

Maxso[®]

X99 Series

1:5 Electric High Speed Handpiece

Instruction For Use



Beyes*

Table of Contents

Symbols.....	2	Technical Specifications	7
Introduction	3-4	Operation.....	8-11
Before Use.....	5	Hygienic maintenance	12-22
Product description.....	6	Limited Warranty	23

Symbols



WARNING!
(Risk of injury)



ATTENTION!
(To prevent damage)



General explanations,
without risk to
persons or objects



Thermal washer
disinfectable



Sterilizable
up to the stated
temperature

Introduction

Customer satisfaction has absolute priority in the *Beyes* quality policy. This *Beyes* product has been developed, manufactured and subjected to final inspection according to legal regulations, quality norms and industry standards.

For your safety and the safety of your patients

Prior to initial use please read the instructions for use. These explain how to use your *Beyes* product and guarantee a smooth and efficient operation.

Intended use

The dental contra-angle handpiece is intended for the following applications: Removal of decayed materials, cavities and crown cement, removal of fillings, finishing and polishing of tooth and restoration surfaces.

Misuse can damage the handpiece and involves risk and danger to user and third parties.

Production according to EU directive

0413 The contra-angle handpiece is a medical product according to the EU-directive 93/42/EEC.

Skilled application

The Maxso handpiece is intended only for skilled application in dentistry according to its purpose of use in compliance with the valid health and safety at work regulations, the valid accident prevention regulations as well as in compliance with these Instructions for Use. The handpiece should be prepared for use and maintained by staff who have been trained in procedures for infection control, personal safety and patient safety. Improper use, (e.g. through poor hygienic maintenance), non-compliance with our instructions or the use of accessories and spare parts which are not approved by *Beyes*, invalidates all claims under warranty and any other claims.

Service

In case of service or repair contact an authorized *Beyes* service partner. Service and maintenance work must only be carried out by an authorized *Beyes* service partner.

Before Use



- Always ensure the correct operating conditions and cooling function.
- Always ensure that sufficient and adequate cooling is delivered and ensure adequate suction. In case of coolant supply failure, the turbine handpiece must be stopped immediately.
- Check the Maxso handpiece for damage and loose parts prior to use (e.g. press button on contra-angle).
- Avoid contact between the instrument head and soft tissue (risk of burning due to the press-button heating up).
- Use only non-contaminated, filtered, oil-free and dry compressed cooling air to operate the Maxso handpiece.
- The operation of the contra-angle is permitted only on dental units which correspond to the standards IEC 60601-1 (EN 60601-1) and IEC 60601-1-2 (EN 60601-1-2).

Hygienic maintenance prior to initial use

The Maxso handpiece is in a clean condition and sealed in PE-film when delivered. Lubricate the contra-angle handpiece prior to initial use. Sterilize Maxso handpiece and nozzle cleaner as well as the limit stop.

- Oil service Page 18
- Sterilization Page 21

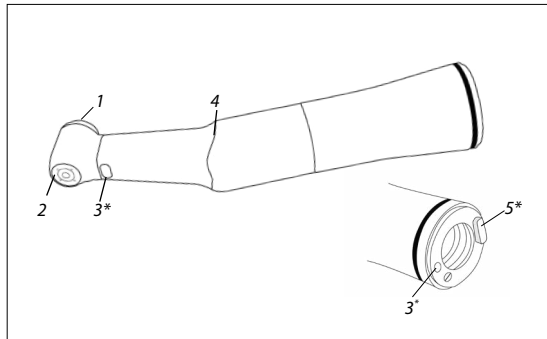

Contra-angles

1. Press button
2. Spray nozzle
3. Compact optic outlet*
4. Grip profile
5. retractable lug*

*only contra-angles with light

Contra-angles	X99 Series
Transmission ratio	1:5
Motor coupling (acc. to standard)	ISO 3964
Instrument (acc. to EN ISO 1797-1:1995) (\varnothing mm)	1.6
Length in mm approved by Beyes (mm)	25*
Min. chuck length	until back stop
Max. motor speed (rpm)	40,000
Spray flow rate (acc. to ISO 7785-2) (ml/min)	> 50
Water setting range (rec. water pressure) (bar)	0.5 – 2 (1.5) **
Chip air setting range (must be higher than the water pressure) (rec. chip air pressure) (bar)	1.5 – 3 (2)**
Chip air consumption at 2 bar (NI/min)	> 1.5

* When using longer rotary instruments (or if the rotary instrument is not inserted up to the limit stop), the user must ensure by correct selection of the operating conditions, that there is no danger to the user, patient or third parties.

** The chip air / water pressure must be set at the same time.

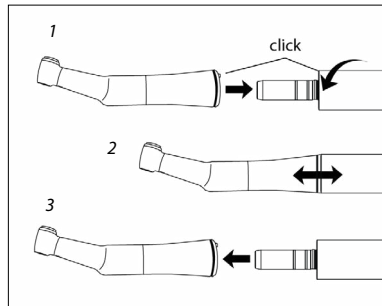

Assembly and removal



Do not assemble/remove during the operation



1. Push the contra-angle handpiece onto the motor and turn it until it engages audibly.
2. Check the connection to the motor is secure
3. Remove the contra-angle handpiece from the motor by pulling in an axial direction.

Rotary Instruments



- Use only rotary instruments which are in perfect condition and which have shanks that meet the requirements of the DIN EN ISO 1797-1 standard. Follow the operating instructions of the manufacturer.
- Insert rotary instruments only when the contra-angle handpiece is stationary.
- Do not interfere with the running or slowing down of rotary instruments.
- Do not activate the rotary chuck of the handpiece or press button of the contra-angle during operation or slowing down. This leads to detachment of the rotary instruments, damage to the rotary chuck(handpiece), and/or makes the press button hot (contra-angle) (risk of injury).

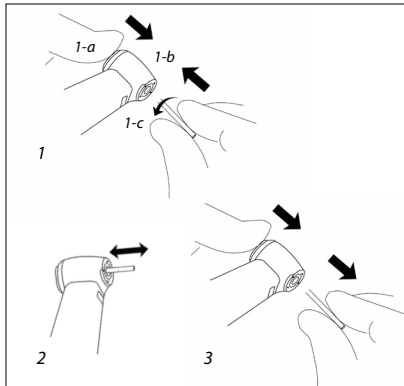

To change rotary instrument into contra-angles

1. Rotary instrument shank \varnothing 1.6 mm: Insert rotary instrument. Press the button firmly (1-a) and at the same time insert the rotary instrument until it reaches the limit stop(1-b).
Rotary instrument shank \varnothing 2.35 mm: Press the button (1-a) and at the same time insert the rotary instrument and turn it until it snaps into place(1-c).
2. Check secure location by applying slight axial tension.
3. Remove the rotary instrument by pushing the press button.

Test run

- Insert rotary instrument.
- Start the contra-angle handpiece.
- If you observe problems (e.g. vibrations, unusual noise, overheating, coolant supply failure or leakage), stop the handpiece immediately and contact an authorized service partner organization.



Always check that the bur is secure before operating the attachment.
Never open or lock bur lock ring while instrument is rotating.

Hygienic maintenance

- Follow your country-specific directives, standards and guidelines for cleaning, disinfection and sterilization.
- You can process the contra-angle handpiece manually or mechanically.

- Wear protective clothing.
- Remove the rotary instrument.
- Remove the contra-angle handpiece from the motor.
- Clean and disinfect the contra-angle handpiece **immediately after every treatment**, to flush out any liquid (e. g. blood, saliva etc.) and to prevent settling on the internal parts.
- Sterilize the Maxso handpiece following manual or mechanical cleaning, disinfection and lubrication.
- Sterilize the nozzle cleaner following cleaning and disinfection.

Pre-disinfection

1. If heavily soiled: Clean first with disinfectant and soft cloths.

- Only use disinfectants that have no proteinfixing effects.

Manual cleaning (internal and external)

2. Rinse under demineralized water (< 38 °C) with the aid of a brush (brush is not recommended in U.K.)
3. Then remove any liquid residues (absorbent cloth, blow dry with compressed air).

- Do not place the handpiece in liquid disinfectant or in an ultrasonic bath.

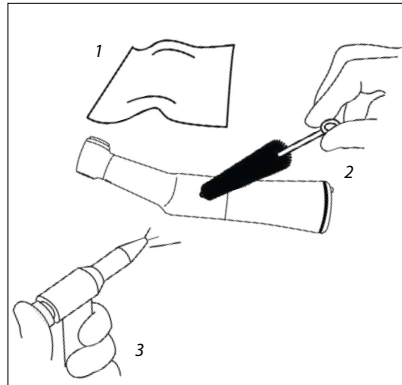

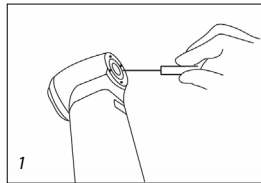

1. Clean spray nozzles

Clean spray nozzles carefully with the nozzle cleaner to remove dirt and deposits.

Clean and disinfect the nozzle cleaner in an ultrasonic bath/disinfection bath.

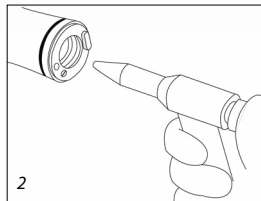

2. Clean coolant tubes

Blow through the coolant tube with an air syringe.

 In the case of clogged spray nozzles or coolant tubes contact an authorized Beyes service partner.

Cleaning of the optic outlet

1. Clean the optic outlet using isopropyl alcohol or other disinfection agents.

2. Blow the optic outlet dry with air syringe or dry it carefully with a soft cloth.

 Avoid scratching the optic outlet!
Never use a cleaning agent that has an ammonium, chlorine, or acid base. Carry out a visual inspection after each cleaning process.

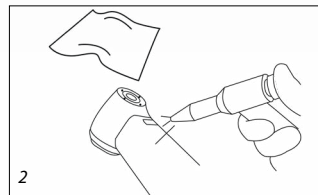
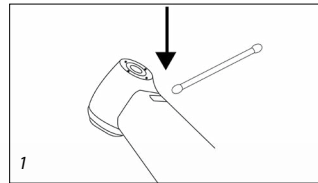

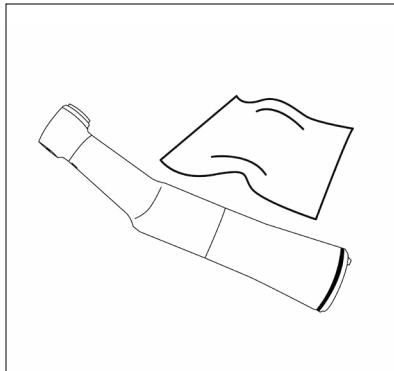

Manual disinfection

- Disinfection with disinfectants, wiping disinfection is recommended.
- Use only disinfectants which do not contain chlorine and which are certified by officially recognized institutes. For USA: Use EPA registered surface disinfectants.
- Note the manufacturer's specifications for the use of the disinfectants.



After manual cleaning, disinfection and lubrication you must carry out a final thermal disinfection (unwrapped) or sterilization (wrapped) in the class B or S steam sterilizer (according to EN 13060).

Mechanical cleaning and disinfection internal and external



The contra-angle can be cleaned and disinfected in a thermo washer disinfectant.



Beyes recommends processing with thermo washer disinfectant.

- Note the manufacturer's specifications on equipment, cleaning agents and detergents.



- Make sure, that the contra-angle is completely dry internally and externally after thermo washer disinfection. Remove any liquid residues with compressed air.
- Lubricate the dry contra-angle immediately after thermo washer disinfection.

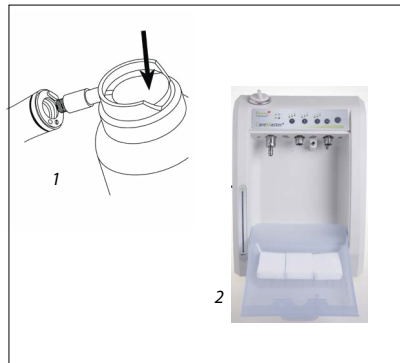

Daily oil service

1. Only with Beyes Lube
Follow the instructions for use of the oil spray can.
or
2. Only with Beyes Caremaster
See instructions for use of Caremaster.

Recommended lubrication cycles

- Essential after every internal cleaning
 - Before each sterilization
- or
- After 30 minutes of use or at least once daily

Weekly oil service of the chuck system

Only with Beyes Lube

- Fit the spray nozzle onto the spray can.
- Hold the contra-angle handpiece firmly.
- Press the tip of the spray nozzle firmly into the chuck system
- Spray for approx. 1 second.

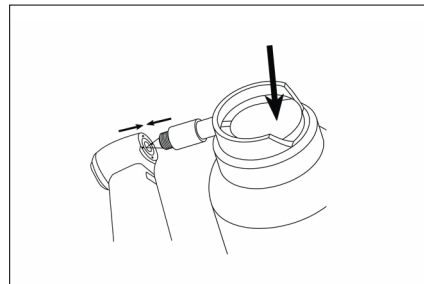

Test run following oil service

1. Place the contra-angle handpiece with the instrument tip/head downwards.
2. Start the contra-angle handpiece for 30 seconds to remove excess oil.
 - Start at the minimum speed and increase to them maximum speed within 5 to 10 seconds.
 - Repeat the entire hygienic maintenance process if dirt emerges.
3. Wipe the contra-angle handpiece with gauze or a soft cloth.

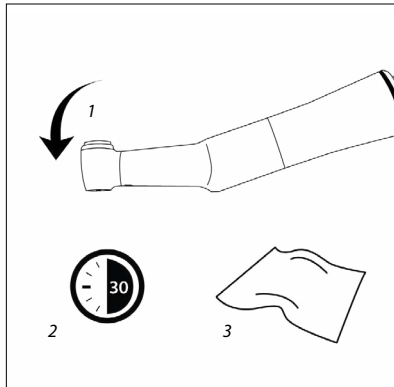

Sterilization and storage

 Beyes recommends sterilization according to EN 13060, class B

- Follow the operating instructions of the manufacturer.
- Clean, disinfect and lubricate prior to sterilization.
- Wrap the contra-angle handpiece and the accessory in sterile goods packing according to EN 868-5.
- Make sure, that you only remove dry sterile goods.
- Store sterile goods dust-free and dry.

Approved sterilization methods



Observe your country-specific guidelines, standards and requirements.

- Steam sterilization class B (pre and post vacuum) with sterilizers in accordance with EN 13060. Sterilization holding time a minimum of 3 minutes at 134 °C (273.2 °F)

or

- Steam sterilization class S with sterilizers in accordance with EN 13060. The sterilizer manufacturer must give their express approval for the sterilization of handpieces/contra-angles. Sterilization holding time a minimum of 3 minutes at 134 °C (273.2 °F)

Beyes Dental Canada hereby warrants against defect in material and workmanship that for a period of 12 months from the date of purchase, this product will perform satisfactorily under normal use and service. No warranty claim can be inferred here, as wear may occur earlier or later than indicated above depending on use, frequency of sterilization and frequency of maintenance. Beyes shall under no circumstances be liable for incidental or consequential damages or damage due to improper use or maintenance.

This Warranty is subject to the following conditions

Beyes will, without charge repair or replace (at Beyes sole discretion) any defective part/s covered in this warranty. If the conditions are met, the defective item must be returned to an authorized Beyes service center or distributor. Accompanied by the original invoice or packing list. This warranty is in lieu of all other warranties, expressed or implied .

* This device is not field repairable

* All brands are holders of their respective trademarks.

Beyes[®]

Beyes Dental Canada Inc.

23-595 Middlefield Road
Scarborough, ON M1V3S2
Canada

Tel: 1-855-603-1888

Email: info@beyes.ca

Website: www.beyes.ca



Lotus NL B.V.

Koningin Julianaplein 10, le Verd,
2595AA, The Hague,
Netherlands



Federal law restricts this device to sale by or on the order of a dentist, physician, or any other practitioner licensed by the law of the states in which he or she practices to use or order the use of this device.

CE
0197

Document #: ENI021
Rev.3 / 09.12.24