

GPRO[®] F1

Gutta Percha Obturation System

Instruction for Use



Table of Contents

1. Introduction.....	3
2. Installation	5
3. Operation.....	7
5. Technical Specification.....	9
6. Signs.....	10
7. Safety precautions.....	11
8. Maintenance.....	11
9. Troubleshooting.....	12
10. After-sales service.....	13
11. Environment protection.....	14
12. Beyes Limited Warranty Statement.....	14

Thank you for purchasing GPro F1 Gutta-percha Obturation System developed by Beyes Dental Canada Inc., Beyes has excellent Quality Control System. To guarantee correct and safe operation, please read this Instruction Manual carefully before use. Depending on the level of risk involved, safety requirements are classed under the following indications:



Danger: (Always refer to personal injury)



Warning: (Refer to possible damage to property)

1. Introduction

1.1 Features

- Cordless and easy to use
- Fast and consistent gutta-percha flow
- Designed for both left handed or right handed individuals; both sides have display window and operation button
- Variable preset temperature settings (150°C, 180°C, 200°C, 230°C)
- Auto shut off after 10 mins of idling

1.2 Intended use

A cordless backfill obturation device that is designed to deliver a fast and continuous flow of gutta-percha for precise root canal obturation.

1.3 Contraindications

Contraindications to the use of this device on patient includes

- Patient allergic to known natural latex and metals such as stainless steel, silver, copper
- Patient with hemophilia
- Patient or dentist with pacemaker implanted
- Patient with heart disease

Note: Use of device on pregnant women or children should be cautious.

1.4 Package includes

- GPro F1 gutta percha obturation gun
- Charging base/stand
- Power adapter
- Gutta-percha injection needles

Model	Gauge	Length
23G 24mm	23G	24mm
23G 28mm	23G	28mm
25G 24mm	25G	24mm

- Heat insulation hood
- Heat insulation sleeve of needle
- Pushing ram
- Cleaning brush
- Wrench
- Instruction Manual
- Qualified Certification
- Packing list

1.5 Diagram of Device

The Gpro F1 is equipped with a display screen and a control button on both the left and right sides. The design of left and right sides are perfectly symmetrical, which enables either left-hand or right-hand operation;

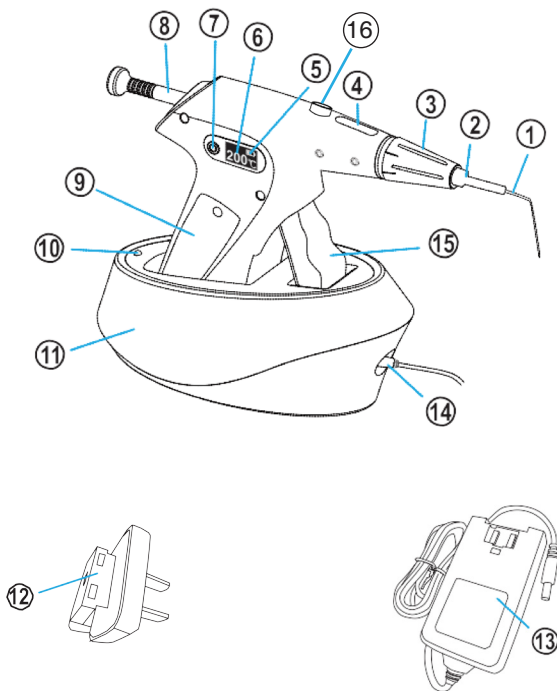

- | | |
|--|--------------------------------------|
| 1. Gutta-percha injection needle | 9. Battery cover |
| 2. Heat insulation sleeve for injection needle | 10. Charging indicator |
| 3. Heat insulation hood | 11. Charging base |
| 4. Gutta-percha loading slot | 12. Power adapter plug |
| 5. Battery level | 13. Power adapter |
| 6. Temperature | 14. Connecting hole for power supply |
| 7. On/off button | 15. Trigger |
| 8. Pushing ram | 16. Ram release |

2. Installation

2.1 Charge device

Install the adapter plug for the power supply (Figure 2)

Plug in the power supply and connect it to the charging base (Figure 3)

Place the device on the base for charging. (Figure 4)

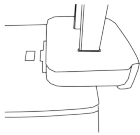

Figure 2

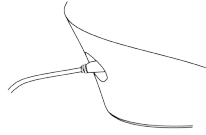

Figure 3

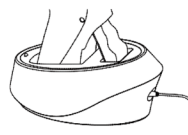

Figure 4

Light on the base will be yellow while battery is charging and will turn green once fully charged.

If the device is off the base, light flashes between yellow and green

Full battery charge takes approximately 2hr 30min

Notes: Charge battery for 3 hours before first use.

Battery Indicator:

The battery indicator displays 5 grids with 1 as lowest to 5 as full battery level.

Indicator shows battery status while charging and it displays 5 grids when fully charged.

Battery should be charged when indicator shows 1 grid.



Warning:

Do not drain battery.

Always keep battery fully charged to maintain battery life.

Recharge battery if the device has not been used for more than 1 month.

2.2 Install needle



Warning:

Make sure the device is off

Allow 5 minutes for device to cool down

Screw in the gutta-percha injection needle to device



Note:

Needles of different sizes are included in the box

Use wrench in the package to fasten the needle.

Turn clockwise to tighten the needle

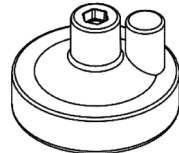

Note:

Turn counter-clockwise to untighten the needle



Warning:

Make sure the device is off.
Allow 5 minute for device to cool down
Do not overtighten the screw.

2.3 Adjust needle

Use wrench to bend needle to different angle for varies application.

Note:

Needles are made of silver which discolors after long-time exposed to air. It should be stored in sealed environment.



Warning:

Needle remains hot after use. To remove the needle, turn off device and allow 5 minutes to cool down.



Warning:

Before each use, clean, disinfect and sterilize the gutta-percha injection needle
Follow manufacturer instruction to disinfect the needle.
Do not autoclave this device.
Do not immerse this device into chemical disinfectant.

2.4 Load Gutta-percha

Select the right size of gutta-percha for operation
Insert gutta-percha into the loading slot



Warning:

Slot fits only 1 gutta-percha pellet.
Too many pellets can damage the device.

Use ram to insert from the back
Stop when you hear a click sound

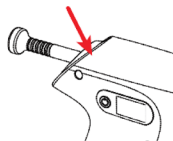
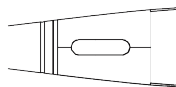

2.5 Clip Heat insulation hood

The translucent insulation hood add an extra heat insulation. It protects doctor or patient from touching the heating chamber. It protects the patient oral tissue and lip from scalding.



Warning:

Keep insulation hood on when device is in use.
Do not touch. Heating chamber is very hot and can burn.

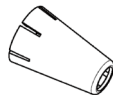

Note:

Disinfect and sterilize the heat insulation hood before each use

3. Operation





3.1 Turn device on/off

Press and hold button for 3 sec. Device turns on. Display shows setting and status.
Press and hold button for 3 sec again. Device turns off. Display turns off.

Note: device automatically shut down after 10 minutes idling

3.2 Select Temperature

Press button to select the temperature setting.
Temperature setting cycles as shown below.

 150°C	 180°C	 200°C	 230°C
Gutta-percha injection needle		Temperature	
25G		180°C-230°C	
23G		180°C-200°C	
20G		180°C-200°C	

The display shows the temperature of heating chamber.

1 second after the temperature is selected, heating chamber will heat up or cool down to the target temperature.

3.3 Apply gutta-percha

Load gutta-percha pellet (see installation)

Make sure the temperature reaches the set temperature.

Squeeze and release the trigger. The ram then steps to push the gutta-percha through the needle.



Warning:

Needle is hot and remains hot after use

Insulation hood should be in place to protect user and patients.

Note:

Needle and insulation hood should be cleaned and disinfected after each patient use.

3.4 Replace gutta-percha



Warning: Do not replace the gutta-percha when device is hot

- 1) Loaded gutta-percha pellet cannot be removed
- 2) Squeeze and release the trigger to push out the remaining gutta-percha
- 3) A click sound during release indicate the end of gutta-percha in the device
- 4) Push the release button to remove the ram from the back
- 5) Reload a gutta-percha



Warning: Do not replace the gutta-percha when device is hot

3.5 Clean heating chamber

After each use, remove all visible leftover gutta-percha obturator in the heat chamber with the cleaning brush

- 1) Set the temperature to 200 °C and allow the device to heat up
- 2) Insert the cleaning brush into the back of the gun and push it through to the front
- 3) Draw the cleaning brush out from the front of the gun

Note: Do not remove the cleaning brush from the back

- 4) Repeat until the chamber is clean

4. Canal Obturation

1. Turn on device and insert a gutta-percha pellet into GPro F1 and adjust to the desired preset temperature
2. Using GPro F1 activated tip, make contact with the upper part of filled master cone in the root canal
3. Pull the trigger to extrude the melted gutta-percha obturator into the canal
4. Slowly retract the needle with continuous flow while withdrawing the tip from the canal
5. Follow with use of GPro P1 heating pen or vertical compaction device to compact obturation material

Note: Fill from the bottom of the root canal to reduce or avoid the generation of bubbles.



Warning:

When the trigger is squeezed to fill the gutta-percha without retracting the needle, the injection needle may break.

While the gutta-percha is still hot, use a warm vertical compaction device to compact obturation material .

If there are bubbles in the root canal, use a small amount of material to fill the root canal for many times. Use a little more material for each filling and use vertical compaction device to press it down.

Note:

Turn off device after each filling
It stops gutta-percha from dripping out.

5. Technical Specification

5.1 Product specifications

Sizes	GPro F1 Gutta Percha Obturation Gun	31.9mm×152.5mm×114.9mm
	Charging base	75.5mm×149.7mm×62.6mm
Weight	GPro F1 Gutta Percha Obturation Gun	170g
	Charging base	207g
	Power adapter	167g

5.2 Technical parameters

Classification	Class II(AC/DC power adapter)	
Optional preset temperatures	150°C-180°C-200°C-230°C	
Time consumption for charging	About 2.5h (First charging needs 3 h)	
Power supply	Input	AC100V-240V 50/60Hz 800mA
	Output	DC15V/1.6A
Battery capacity	Chargeable battery	2000mAh

5.3 Environmental parameters



















	Working	Storage
Temperature	+5°C~+40°C	-20°C~ +55°C
Humidity	30%~75%	10% ~ 93%
Air pressure	70kPa~106kPa	70kPa ~ 106kP



Warning:

Do not transport and store this device with hazardous articles such as combustible poisonous, caustic, or explosive.

6 Signs

	Product serial number		Follow Instructions for Use
	Manufacturer		Date of manufacture
	Type B applied part		Class II equipment
	Power switch		Ordinary equipment
	Used indoor only		Device complies with WEEE directive
	Can be autoclaved		Keep dry
	Handle with care		Recovery
	Attention! Please refer to the accompanying documents.		
	Humidity limit for storage: 10% ~ 93%		
	Atmospheric pressure for storage: 70kPa ~ 106kPa		
	Temperature limit for storage: -20°C ~ +55°C		

7. Safety precautions

1. Do not use instruments other than the provided wrench to install, disassemble or pre-bent gutta-percha injection needle.
2. Do not knock or scratch the the GPro F1 gutta percha obturation gun.
3. Do not place the the GPro F1 gutta percha obturation gun near an electronic device, phone, radio or HD/ satellite TV as these may affect the temperature control of the GPro F1 gutta percha obturation gun.
4. Keep heat carrier accessories such as the GPro F1 gutta percha obturation gun, gutta-percha injection needle, heat insulation hood etc. under heating state away from inflammable and explosive materials.
5. Please keep the device clean before and after operation. Before each use, please clean, disinfect and sterilize the accessories such as gutta-percha injection needle, heat insulation hood and wrench.
6. Users should be equipped with adequate protection such as goggles, mask, etc. to prevent cross-infection.
7. The product should be in strict accordance with relevant operation specifications of medical authority and relative regulations. The product can only be operated by trained doctors or technicians.
8. Do not install, remove, or replace the heat insulation hood and injection needle under heating state. If you need to replace the injection needle, please first power off and wait for 5 minutes. Five minutes later, if the the GPro F1 gutta percha obturation gun totally cools down, replace the injection needle.
9. The injection needle must be correctly installed to prevent from falling off or gutta-percha leakage during operation.
10. Do not use excessive force when pre-bending the injection needle to prevent the injection needle from breaking. When the injection needle is bent or worn, the gutta-percha flowing ability may be deteriorated, and the operator should replace the new injection needle in time according to the clinical condition;
11. Beyes is specialized in producing medical instrument. We are only responsible for the safety on the following conditions:
 - a) The maintenance, repair, and modification are made by the manufacturer or the authorized dealers.
 - b) The charged components are original of "Beyes" and operated according to instruction manual.

8. Maintenance

8.1 Cleaning, disinfection and sterilization

After use, squeeze out all the residual materials inside heating chamber, power off the device, pull the pushing ram out of the GPro F1 gutta percha obturation gun from the back side, and remove the material on the top of pushing ram.

1) Cleaning of charging base and the GPro F1 gutta percha obturation gun

The charging base and the surface of the GPro F1 gutta percha obturation gun can be wiped with a soft towel with a small amount of neutral detergent or disinfectant alcohol.

2) Heat insulation hood

Before first use and before used to different patients, please clean, disinfect and sterilize it. It is recommended to execute steam sterilization after washing with water or washing in ultrasonic cleaner.

3) Gutta-percha injection needle

After being used on each patient, please change the needle each time. When there is a found or suspected damage to the needle, place it in a fixed recycling container.

4) Cleaning of heating chamber

When removing the residue inside the heating chamber and the loading slot, set the temperature of the device to 200 °C, and then power off the device after squeezing all the residual materials out. After pulling the pushing ram out from back part, insert the supplied cleaning brush from the back of the device and pull it out from the front part of the GPro F1 gutta percha obturation gun. Please take care not to add any cleaning agent or chemicals to the cleaning brush.

5) Pushing ram

Use sterile alcohol and gauze to remove any visible residue.

6) The gutta-percha injection needle, heat insulation hood, and wrench can be cleaned with clean water as well as can be cleaned in an ultrasonic cleaner;

7) After each use, please sterilize the gutta-percha injection needle, heat insulation hood, and wrench under high temperature and high pressure (134°C, 0.22MPa) for at least 4 minutes.

8) If the other accessories need to be cleaned or disinfected, please use gauze to pick up a small amount of water or disinfectant to wipe the surface. Do not soak those accessories in the cleaning solution.

9) Do not use volatile and diffluent solvents for cleaning, which will damage the surface of the device or cause the markings on the machine to fade.

8.2 Daily maintenance

When the device is not used, please turn off the power and unplug the power supply plug. If the the GPro F1 gutta percha obturation gun is in a low battery state for a long time, the service life of battery will be shortened. Please charge it in time if the battery level is low. When the device is not used, please charge it for 1 hour once a month.

8.3 Repair of device

This product does not contain self-repairing spare parts. Repair should be carried out by a designated professional or special repair shop.

9. Troubleshooting

Fault	Cause	Solution
After pressing the "ON/OFF" button, the device is still off.	<ol style="list-style-type: none">1. Inadequate battery power2. Battery is damaged.3. The charging interface is short-circuited, causing the lithium battery to enter a protection state;4. GPro F1 gutta percha obturation gun is damaged.	<ol style="list-style-type: none">1. Connect to power supply to charge. / Replace the battery.2. Replace the battery.3. Remove the substance that causes the short circuit, put the device into the charging base to charge, and then the device will return to normal;4. Contact local distributor or manufacturer.
Gutta-percha cannot flow out from the needle	<ol style="list-style-type: none">1. The push ram has been pushed to the end, indicating that the gutta-percha has run out.2. The pushing ram seal ring is damaged.3. The injection needle is damaged and blocked	<ol style="list-style-type: none">1. Pull back the pushing ram and load a new gutta-percha stick.2. Replace the pushing ram3. Replace the injection needle
Automatic shutdown	If there is no operation for 10 minutes, the device will automatic powers off	Reboot

The pushing ram cannot be pulled out	The portion of the pushing ram that enters the interior of the heating chamber is fixed by the cooling of the gutta-percha.	<ol style="list-style-type: none"> 1. Power on and set the temperature to 200 °C. After the temperature reaches the set value, pull out the pushing ram back; 2. Contact your local dealer or our company.
Charging failure after connecting to power supply.	<ol style="list-style-type: none"> 1. The power supply is not correctly connected; 2. The power supply is damaged, or the specification doesn't match. 3. There are impurities on the contact thimble of charging base. 	<ol style="list-style-type: none"> 1. Unplug and reconnect. 2. Replace the battery. 3. Wipe the thimble with alcohol, dry it, and reconnect.
The service time after each charging is shortened.	The battery capacity becomes smaller.	Send to the repair center.
ERROR code appears on display screen	The heating chamber is damaged.	<ol style="list-style-type: none"> 1. Send to the repair center. 2. Contact local distributor or manufacturer.

If the problem still cannot be solved, please contact your local dealer or Beyes Dental Canada Inc.

1. When the pushing ram is in the the GPro F1 gutta percha obturation gun, please do not push or pull the pushing ram vigorously. When the gutta-percha is heated up to the preset temperature, the pushing ram should be pushed by pulling the trigger for multiple times. If the pushing ram does not move, try to push it manually with a slight force, and try to pull the trigger.
2. Please refer to the recommended temperature to set the preset temperature.
3. To remove all remaining material, please first remove the injection needle, and then pull the trigger to squeeze out all the residual material in the heating chambers. Be careful not to touch the head of the the GPro F1 gutta percha obturation gun to avoid scalding. Power off, cool it down slightly, and push the pushing ram down.

10. After-sales service

Starting from the date of sales, if the device does not function up to standard due to manufacturer defect, our company will be responsible for the repair of device during its warranty period. Please refer to the warranty card for warranty period and scope.

11. Environment protection

The device does not contain any harmful substances. It may be handled or disposed in accordance with the relevant local regulations.

Note:

- 1) Without Beyes agreement and authorization, private modification of device may result in the electromagnetic compatibility problem of that device or other devices.
- 2) The design and test of the GPro F1 gutta percha obturation gun complies with the related operation regulations of electromagnetic compatibility.

12. Beyes Limited Warranty Statement

11.1 SCOPE OF WARRANTY

BEYES Dental Canada Inc. warrants to the original retail purchaser that it will be at BEYES option to repair or replace components of the dental products manufactured by BEYES (except for components not warranted under 'Exclusions') that are defective in material or workmanship under normal use and service. BEYES' obligation under this limited warranty is limited to the repair or replacement of the applicable components. This limited warranty shall only apply to defects that are reported to BEYES within the applicable warranty period and which, upon examination by Beyes, prove to be defective. This warranty extends only to the first retail purchaser of a product and is not transferable or assignable. Replacement components or products may be used and/or refurbished components or products, provided they are of like quality and specifications as new components or products.

11.2 APPLICABLE WARRANTY PERIOD

The applicable warranty period, measured from the date of invoice to the original user, shall be as follows

GPro F1 are warranted for a period of 12 months

11.3 EXCLUSIONS

This limited warranty does not cover and BEYES shall not be liable for the following;

1. Defects, damage or other conditions caused, in whole or in part, by misuse, abuse, negligence, alteration, accident, freight damage, negligent storage, tampering or failure to seek and obtain repair or replacement in a timely manner;
2. Products which are not installed, used, and properly cleaned and maintained as required or recommended in the BEYES 'Installation' and/or 'Installation/Operation Manual' for the applicable product, including the specified structural and operational environment conditions and electrical power requirements;
3. Products considered to be of a consumable or sterile nature;
4. Accessories or parts not manufactured by BEYES;
5. Charges by anyone for adjustments, repairs, replacement parts, installation or other work performed upon or in connection with such products which are not expressly authorized in writing in advance by BEYES;
6. Costs and expenses of routine maintenance and cleaning;
7. Representations and warranties made by any person or entity other than BEYES;
8. Matching of color, grain or texture except to commercially acceptable standards;
9. Changes in color caused by natural or artificial light;
10. Custom manufactured products;
11. Alterations or modifications to the product by any person or entity other than BEYES;
12. Products that would otherwise be covered under Sections 1 and 2 of this limited warranty, but are acquired: (i) from a person or entity that is not BEYES or one of its authorized dealers;

or (ii) from a BEYES dealer that is not authorized to sell the product at issue in the geographic territory where the purchaser is located, or is not authorized to sell the product at issue within the medical, animal health or dental market, as the case may be, in which purchaser intends to use the product.

11.4 EXCLUSIVE REMEDY; CONSEQUENTIAL DAMAGES DISCLAIMER

Beyes' obligation under this limited warranty is the repair or replacement of defective parts. Beyes shall not be liable for and hereby disclaims any direct, special, indirect, incidental, exemplary or consequential damages or delays, including, but not limited to, damages for loss of profits or income, loss of use, downtime, cover and employee or independent contractor wages, payments and benefits.

11.5 WARRANTY DISCLAIMER

This limited warranty is Beyes only warranty and is in lieu of all other warranties, express or implied. Beyes makes no implied warranties of any kind including any implied warranties of merchantability or fitness for a particular purpose. This warranty is limited to the repair or replacement of defective parts.

11.6 STATUE OF LIMITATIONS

No actions may be brought against Beyes for breach of this limited warranty, or implied warranty, if any, or for any other claims arising out of or relating to the products, more than ninety (90) days following expiration of the limited warranty period.



Federal law restricts this device to sale by or on the order of a dentist, physician, or any other practitioner licensed by the law of the states in which he or she practices to use or order the use of this device.

Beyes Dental Canada Inc.
23-595 Middlefield Road
Toronto, Ontario, M1V 3S2
Canada
Tel: 1-855-603-1888
Fax: 1-855-720-1228
Email: info@beyes.ca
Website: www.beyes.ca



Lotus NL B.V.
Koningin Julianaplein 10, Ie Verd,
2595AA, The Hague,
Netherlands
Tel: +31645171879 (English)
+31626669008 (Dutch)
Email: info@beyes.ca
Website: www.beyes.ca



Printed in Canada
ENI035
Rev. 1/11.03.21