

Duray[®] V2











































DC X-Ray Unit

Service & Installation



Beyes[®]
CANADA

Graphic symbols

	European Community mark - IMQ notified body		Type B applied part		Switch OFF
	Caution		Non-ionizing electromagnetic radiation		Switch ON
	Notice		Small focal spot		System ready
	Follow operating instructions		Inherent filtration		Mains phase 1 live
	Operating instruction		Irradiation light on hand-switch		Mains neutral
	Separate Collection, Do Not Dispose		Irradiation light on control panel		Mains phase 2
	Temperature limitation		Exposure release		Protective earth (PE)
	Date of manufacture		Manufacturer		Earth
	Chemical Film		Phosphor plate		Digital sensor
	MENU key		Increment		Decrement
	kV level selection		Child build		Adult build
	Upper Incisor		Upper cuspid/premolar		Upper molar
	Occlusal		Premolar crowns		Molar crowns
	Lower Incisor		Lower cuspid/premolar		Lower molar

Acronyms

AC	Alternating Current	IT	Indicator of Italian language
AWG	American wire gauge	JIG	Custom-made tool
BLD	Beam Limiting Device	LED	Light Emitting Diode
CPU	Central Processing Unit	MS	Mobile Stand
DAP	Dose Area Product	PCB	Printed Circuit Board
DC	Direct Current	PE	Protective Earth
DE	Indicator of German language	PT	Indicator of Portuguese language
ES	Indicator of Spanish language	SA	Support Arm
FA	Folding (scissor) Arm	SCU	System Control Unit
FDA	Food and Drug Administration	SSD	Source Skin Distance
FR	Indicator of French language	THA	Tube Housing Assembly
GB	Indicator of English language	WA	Wall Adaptor
HV	High Voltage	USA	United States of America

Valid from:

Manufactured by

Beyes Dental
Canada Inc.

Table of contents

1.	Introduction	4			
1.1	Technical data summary	4			
1.2	Dimensions of wall systems	5			
2.	System configurations	6			
2.1	Wall mounted systems	6			
2.2	Mobile system	7			
3.	Electronic boards	8			
3.1	Power driver board	8			
3.2	Filament calibration board	9			
3.3	Control unit board and touch interface board	9			
4.	System control menus	10			
4.1	Setting system parameters	10			
4.2	Checking system parameters and current DAP values	10			
4.3	Service data	10			
5.	Installation of wall system	11			
5.1	Mounting the Folding Arm (FA)	11			
5.1.1	Possible means of installation	11			
5.1.1	Unit in the treatment room with local hand-switch	11			
5.1.2	Unit in the treatment room with hand-switch remote	11			
5.1.3	X-ray emission in the treatment room with remote control and release switch	11			
5.2	Structural Requirements	12			
5.3	Mounting system modules	13			
5.3.1	Mounting the wall adaptor (WA)	13			
5.3.2	Mounting the system control unit (SCU)	14			
5.3.3	Mounting the Support Arm (SA)	14			
5.6.1					
5.3.6	Mounting the beam limiting device (BLD)	16			
5.4	Connecting system modules	17			
5.4.1	Connecting the cable in the joint of the THA	17			
8.3	5.4.2 Connecting SA to PE point	17			
5.4.3	Connecting output cables to SCU	17			
5.4.4	Connecting the X-ray THA to a distant SCU	19			
5.4.5	Connecting the X-ray hand-switch	20			
5.5	Optional connections	20			
5.5.1	Connecting the X-ray hand-switch remote and key lock	20			
5.5.2	Activation of door contact and additional enable	21			
5.5.3	Activation of warning lights	21			
5.6	Connection to mains power supply	22			
	Configuring SCU for mains power supply	22			
	5.6.2 Connecting SCU to mains power supply	22			
5.7	Final system set-up	23			
6.	Installation of mobile system	24			
6.1	Mounting and connecting mobile system modules	24			
6.1.1	Assembling the mobile stand	24			
6.1.2	Mounting FA on mobile stand	24			
6.1.3	Mounting the THA	24			
6.1.4	Mounting the BLD	24			
6.1.5	Connecting the cable in the joint of THA	24			
6.1.6	Preparing the mains supply cord	24			
6.1.7	Mounting SCU on mobile stand	25			
6.1.8	Connecting output cables to SCU	25			
6.1.9	Connecting the X-ray hand-switch	25			
6.1.10	Configuring SCU for mains power supply	25			
8.1	Checking labels	31			
8.2	Maintenance of wall adaptor (WA)	32			
	6.1.12 Final system set-Up	25			
7.	Service	26			
7.1	Line fuses	26			
7.2	THA test JIG	26			
7.3	Replacement of X-ray THA	26			
7.4	Replacement of the system control unit (SCU)	28			
7.5	Exchange of power driver board	29			
7.6	Replacement of mains supply cord	30			
8.	Maintenance	31			
	Maintenance of support arm (SA)	32			
8.4	Maintenance of folding arm (FA)	32			
8.5	Maintenance of THA	34			
8.6	Electrical Checks	34			
8.9	Maintenance of the mobile stand	37			
8.10	Probe current verification	37			
8.11	Maintenance of the system control unit (SCU)	38			
8.11	Exposure time and KV verification	38			
8.12	Mechanical checks	39			
8.12	Radiation dose assessment	39			
9.	Reporting	40			
9.1	Installation report	40			
9.2	Report on periodic inspection and preventive maintenance	41			

1. Introduction

Documentation The accompanying documents supplied with the system include the following documents which are integral parts of the product:

- DURAY V2 Operating Instructions
- DURAY V2 Service and Installation Manual

Technician Requisites

Skills:

- Connection of equipment to the main line
- Installation of radiographic equipment
- Knowledge of radiation protection

1.1 Technical data summary

Packaging Wall systems	Wall unit, Support Arm S 30 cm, Circular BLD, source skin distance (SSD) 20 cm	Size: 97x27x34 cm (38 1/8x10 5/8x13 3/8") Gross weight: 28 kg (62 lbs)
	Wall unit, Support Arm M 60 cm, Circular BLD, SSD 20 cm	Size: 97x27x34cm (38 1/8x10 5/8x13 3/8") Gross weight: 29 kg (64 lbs)
	Wall unit, Support Arm L 80 cm, Circular BLD, SSD 20 cm	Size: 97x27x34 cm (38 1/8x10 5/8x13 3/8") Gross weight: 30 kg (66 lbs)
	Wall unit, Support Arm XL 100 cm, Circular BLD, SSD 20 cm	Size: 115x27x34 cm (45 1/4 x10 5/8x13 3/8") Gross weight: 31 kg (68 lbs)
Packaging Mobile systems	Mobile unit, Circular BLD, SSD 20 cm	Size: 97x27x51 cm (38 1/8x10 5/8x20 1/8") Gross weight: 58 kg (128 lbs)

Power supply	Nominal Line Voltage	110-127 V ± 10%, 220-240 V ± 10%
	Line Frequency	50 /60 Hz
	Maximum Line Current	8 A at 110-127 V, 5 A at 220-240 V
	Permissible apparent impedance of supply mains	≤ 0.5 Ohm at 110-127 V, ≤ 1.0 Ohm at 220-240 V
	Line voltage regulation for maximum line current:	2.6% at 120 V, 1.3 % at 240 V (maximum voltage drop 3.0 V)
	Line fuses	T 8AL, 250 V (time lag) at 110-127 V, T 5AH, 250 V (time lag) at 220-240 V second fuse available for two phases supply or for non-permanent connection to mains with plug
	Power input upon radiation	1.1 kVA at 200-240 V, 0.95 kVA at 110-127 V
	Power input standby mode	< 6 VA

Wall suspension	Arm Length	Short (S): 30 cm /11 3/4", Medium (M): 60 cm /23 5/8", Long (L): 80 cm /31 1/2", Extra Long (XL) 100 cm /39 3/8"
	Useful Reach with cone for 20 cm (8") SSD	143 cm /56 1/4" with Short (S) arm 173 cm /68 1/8" with Medium (M) arm 193 cm /76" with Long (L) arm 213 cm /83 7/8" with Extra Long (XL) arm

Transport	Temperature, transport	From -20°C to +50°C (from -4°F to 122°F)
	Relative humidity, transport	From 10 to 90%
	Pressure, transport	from 500 to 1060 hPa

Operation	Temperature, operation	From 10 to 40 °C (from 50°F to 104°F)
	Relative humidity, operation	From 30 to 75%
	Pressure, operation	From 700 to 1060 hPa

1.2 Dimensions of wall systems

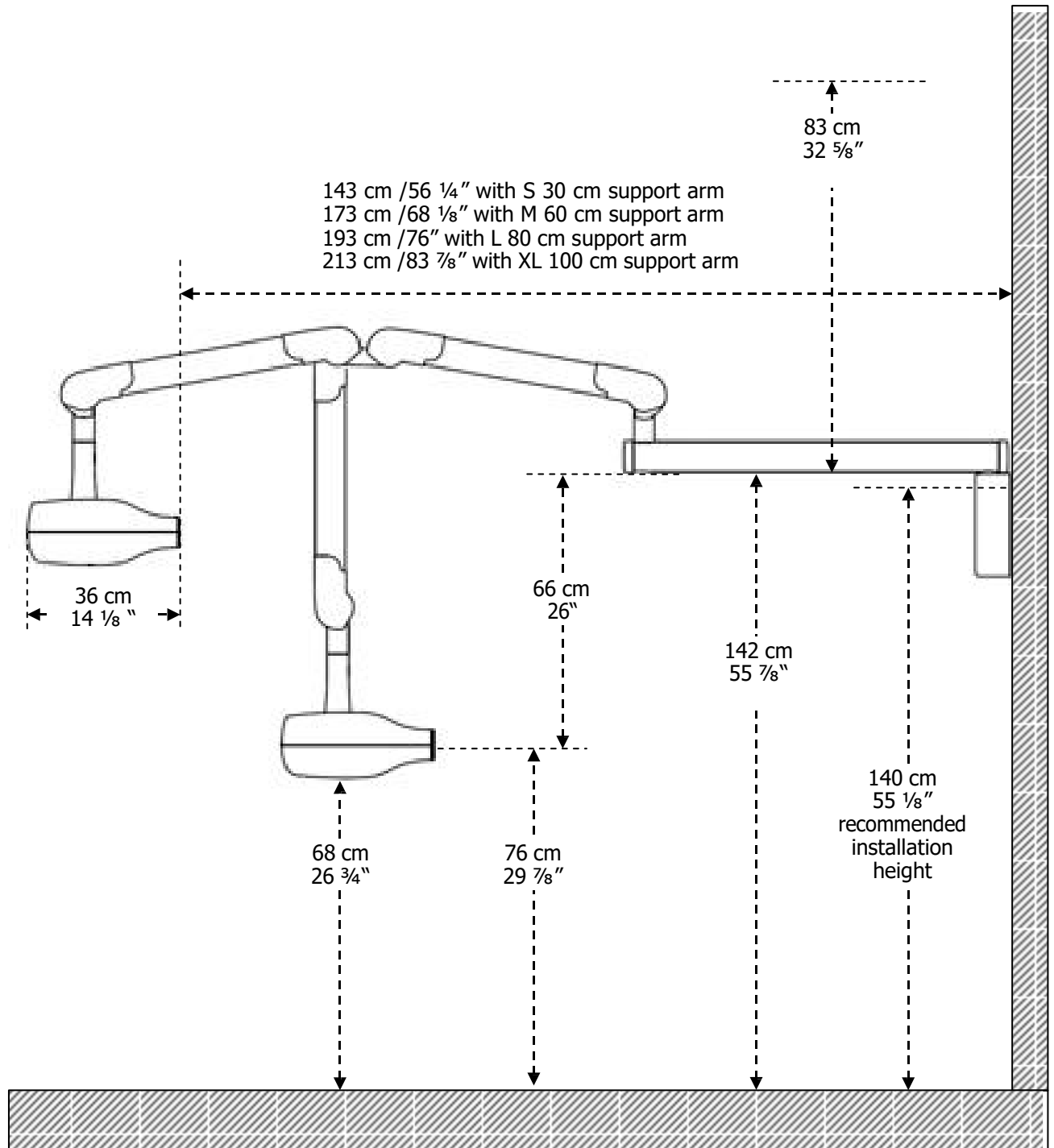

- 140 cm (55 1/8") is the recommended installation height of the top bolts of the WA from the floor
- The maximum reaches from the wall refer to the four possible configurations for SSD 20 cm (8") equipped with short (S), medium (M), long (L), and extra-long (XL) support arms.

2. System configurations

2.1 Wall mounted systems

	Description	Code
Preferred System	Wall System, Support arm S 30 cm, Circular BLD, 20 cm SSD	97 590 62320
	Wall System, Support arm M 60 cm, Circular BLD, 20 cm SSD	97 590 62620
	Wall System, Support arm L 80 cm, Circular BLD, 20 cm SSD	97 590 62820
	Wall System, Support arm XL 100 cm, Circular BLD, 20 cm SSD	97 590 62120

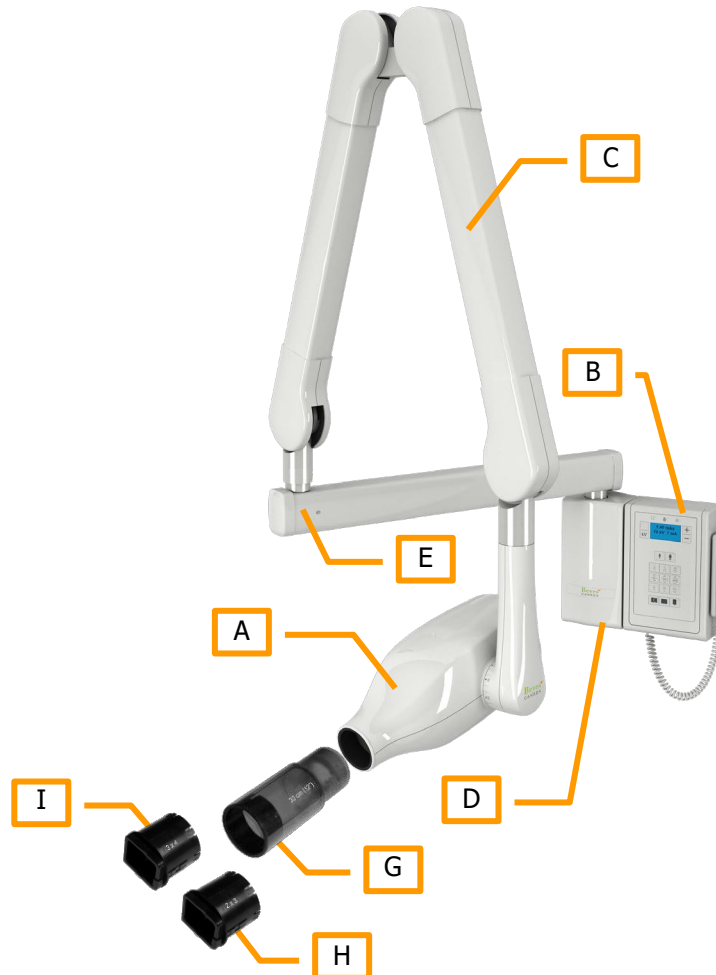

	ID	Description	Code
Loose components	A	X-ray tube housing assembly XDC	93 190 01700
	B	System control unit XDC with hand-switch	93 190 70200
	C	Folding arm XDC	93 190 12010
	D	Wall adaptor XDC	93 190 11000
	E	Support arm S 30 cm	93 190 17100
		Support arm M 60 cm	93 190 17200
		Support arm L 80 cm	93 190 17300
		Support arm XL 100 cm	93 190 17400

	ID	Description	Code
Accessories	G	Cone Extension XDC 10 cm (4") for 30 cm (12") SSD	91 190 00010
	H	BLD adaptor 2x3 cm, film size 0	91 190 00030
	I	BLD adaptor 3x4 cm, film size 2	91 190 00040

2.2 Mobile system

		Description	Code
Preferred System	Mobile system		97 590 67820

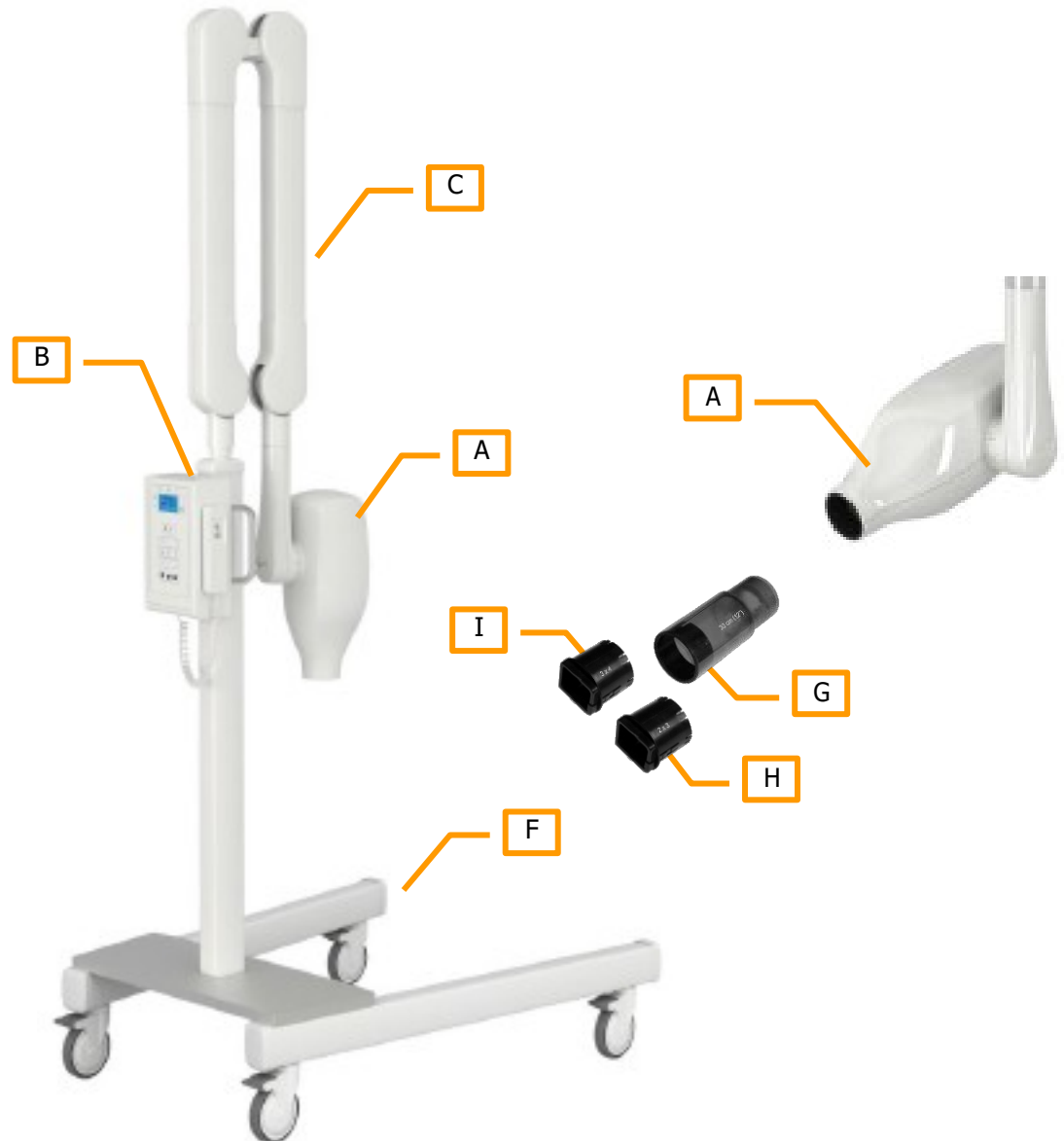

	ID	Description	Code
Loose components	A	X-ray tube housing assembly XDC	93 190 01700
	B	System control unit XDC with hand-switch	93 190 70200
	C	Folding arm XDC	93 190 12010
	F	Mobile stand XDC	93 190 20080

	ID	Description	Code
Accessories	G	Cone Extension XDC 10 cm (4") for 30 cm (12") SSD	91 190 00010
	H	BLD adaptor 2x3 cm, film size 0	91 190 00030
	I	BLD adaptor 3x4 cm, film size 2	91 190 00040

3. Electronic boards

The System Control Unit (SCU) is composed of 2 modules each made of 2 boards:

- Power driver module, comprising
 - Power driver board
 - Filament calibration board
- Control unit module, comprising
 - Control unit board, with CPU and display
 - Capacitive touch interface board

3.1 Power driver board

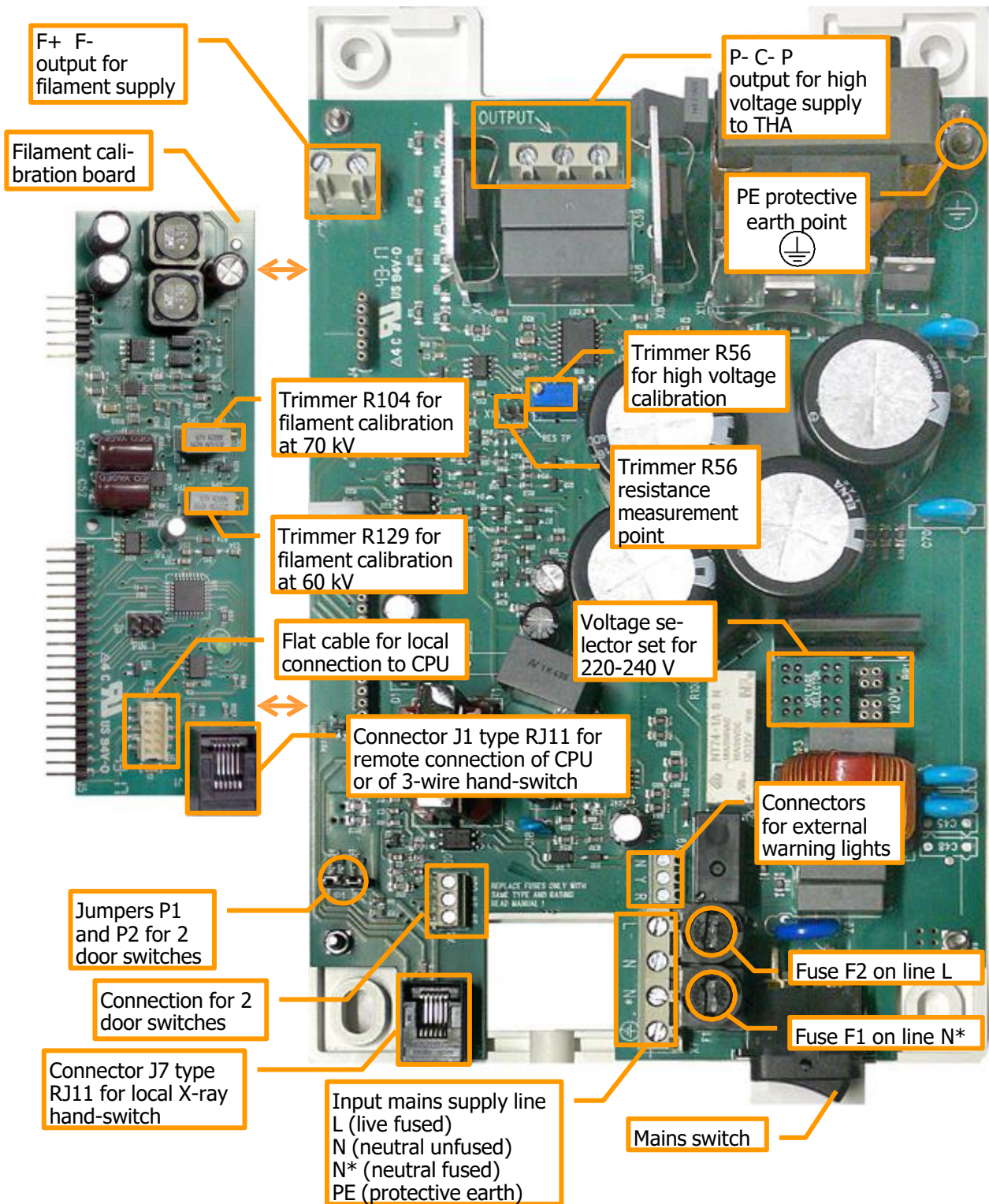

3.2 Filament calibration board

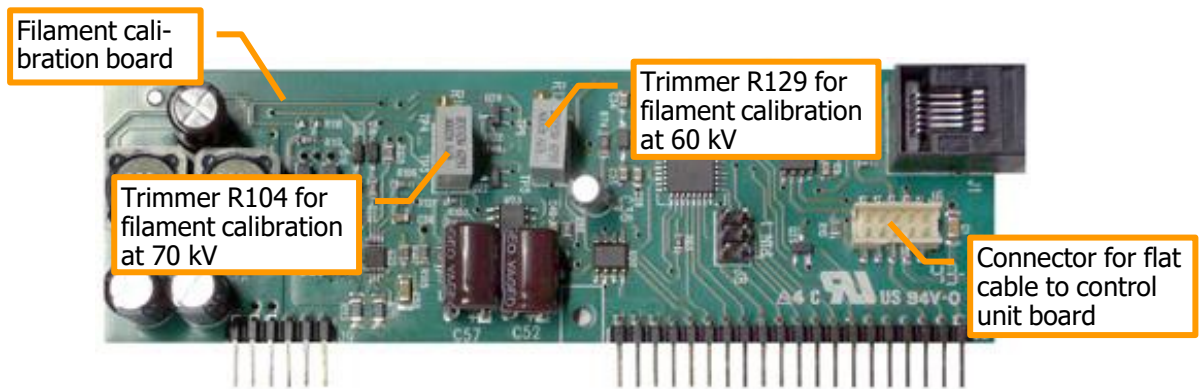

3.3 Control unit board and touch interface board

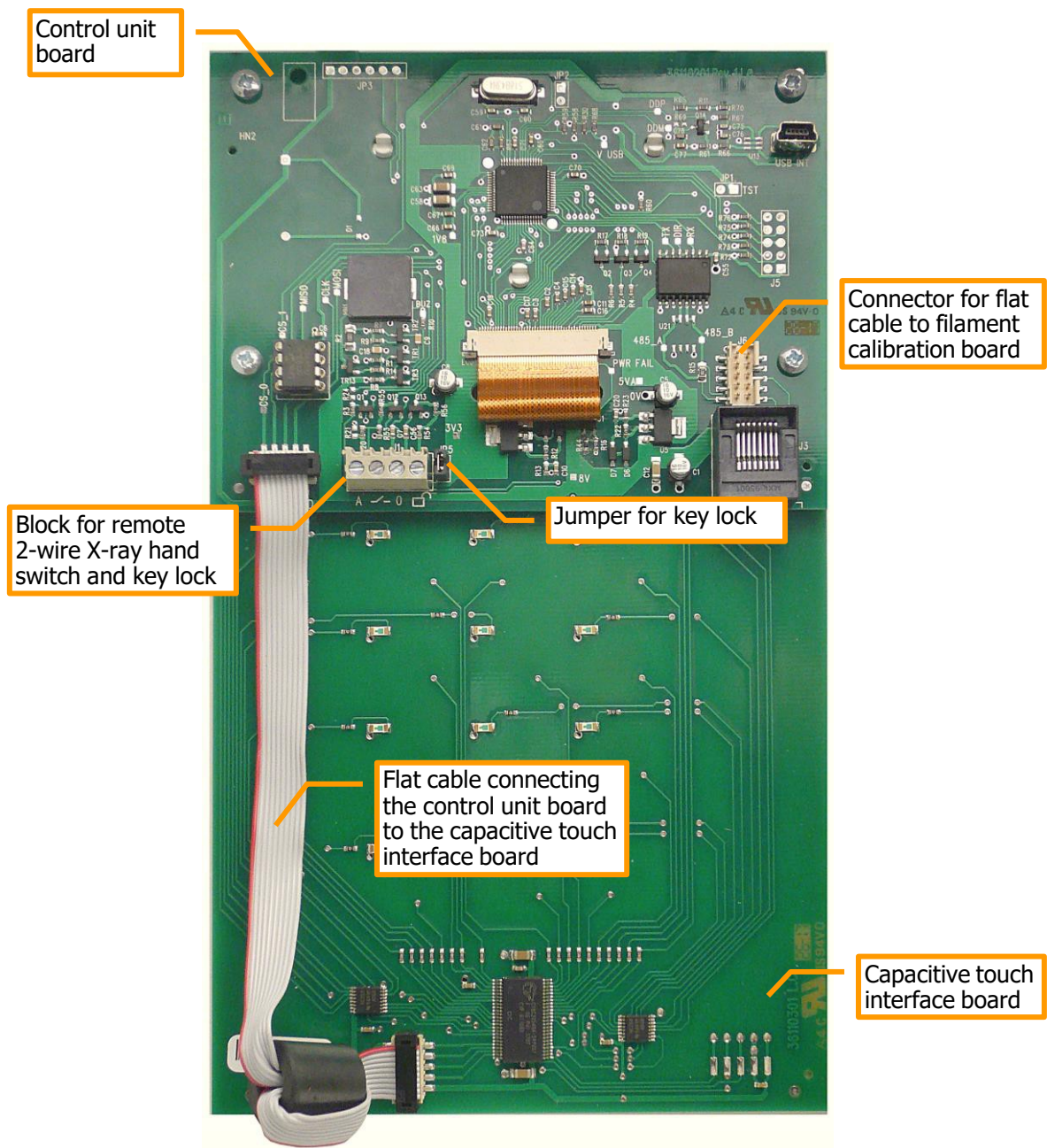

4. System control menus

4.1 Setting system parameters

Configuration

- A. The User Menu is available for system configuration.
 - a. Press MENU and ADULT keys together to enter.
 - b. Press the kV key to go to the NEXT step.
 - c. Press the hand-switch push button to exit.
- B. User settable parameters:
 - a. Technique factor: s (default) or mAs.
 - b. Cone length (SSD): 20 cm (8") (default) or 30 cm (12").
 - c. BLD shape: Circular (default) or rectangular size 2 or size 0.
 - d. Film sensitivity: defaulted to 2.0.
 - e. Phosphor plate sensitivity: defaulted to 1.0.
 - f. Digital sensor sensitivity: defaulted to 0.5.
 - g. DAP on display: OFF (default) or ON.
 - h. Demo mode setting: OFF (default) or ON.
 - i. Display contrast: range 5 to 63 (default 55).
 - j. Language selection: English, Italiano, Español, Français, Português, Deutsch.
 - k. Factory setting: reset to factory setting option.

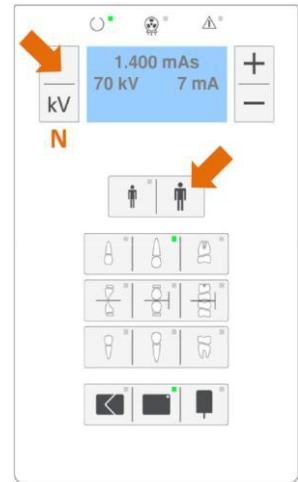

4.2 Checking system parameters and current DAP values

- A. A key sequence is available to display the configured parameters and the matrix of current DAP values.
 - a. Press MENU and CHILD keys together to enter.
 - b. Press the kV key to go to the NEXT step.
 - c. Press the hand-switch push button to exit.
- B. Two pages are shown:
 - a. Exposure indexes as set for the imaging receptors.
 - b. Current DAP values for the selected technique factors and unit of measurement adopted.

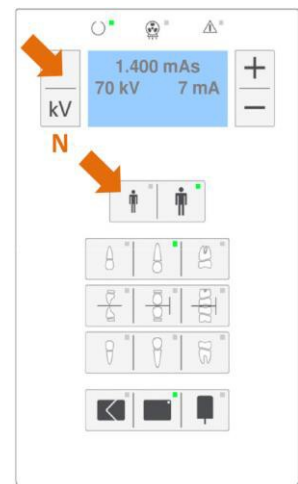

4.3 Service data

- A. A key sequence is available to display service data.
 - a. Press MENU and PLUS keys together to enter.
 - b. Press the hand-switch push button to exit.
 - c. Activate the display function by pressing at the same time the two keys MENU and PLUS.
- B. Service data reported include:
 - a. Current version of CPU software.
 - b. Current version of Driver software.
 - c. Current version of EEPROM.
 - d. Cumulative counter of exposures done.
 - e. Cumulative counter of generated energy (kJ).

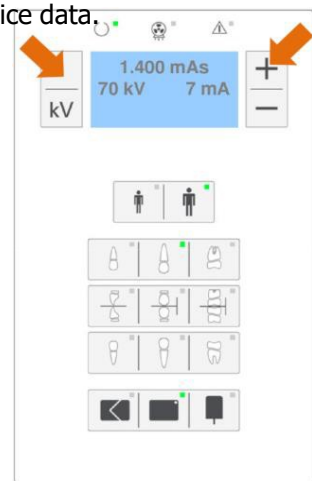

5. Installation of wall system



Risk of EMC interference.



The unit has not to be placed or activated close to other equipment which could disturb it or which could be disturbed.

5.1 Possibilities of installation

5.1.1 Unit in the treatment room with local hand-switch

The X-ray hand-switch is placed locally.

The following connections to be realized:

- Mains power supply (live, neutral, protective earth wires) entering the SCU at bottom
- Output power cable and filament supply plus protective earth connection exiting from SCU at top, to enter the WA
- Optional:
 - Wires for key-lock contact
 - Wires for door contact
 - Wires for external warning lights



5.1.2 Unit in the treatment room with hand-switch remote

The X-ray hand-switch is placed remotely.

The following connections to be realized:

- Mains power supply (live, neutral, protective earth wires) entering the SCU at bottom
- Output power cable and filament supply plus protective earth connection exiting from SCU at top to enter the wall adaptor
- The cable for remote hand-switch is connected internally to the SCU
- Optional:
 - Wires for key-lock contact
 - Wire for door contact
 - Wires for external warning lights

A box for remote X-ray hand-switch is optionally available

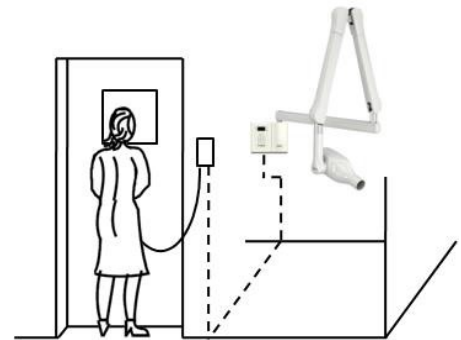

5.1.3 X-ray emission in the treatment room with remote control and release switch

The X-ray hand-switch is connected to the SCU placed remotely.

The following connections to be realized:

- Mains power supply (live, neutral, protective earth wires) entering the SCU at bottom
- Long (12 m maximum) output power cable and filament supply plus protective earth exiting from SCU at top, to the connection block into the WA
- Additional protective earth connection from the mains line
- The X-ray hand-switch is connected externally to the SCU, remotely placed
- Optional:
 - Wires for key-lock contact
 - Wires for door contact
 - Wires for external warning lights

A Kit of 12 m (40') supply cables for THA XDC is optionally available

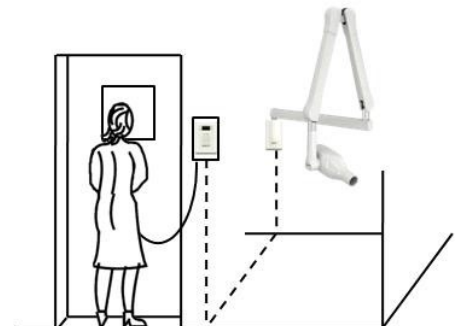

5.2 Structural Requirements

Useful Reach

The WA has to be mounted in a convenient position on the left or right side of the chair or on the back wall (head of the patient). The useful reach depends on the length of SA and cone mounted (source skin distance, SSD).

DURAY V2 Useful Reach		
Support Arm	SSD 20 cm (8")	SSD 30 cm (12")
Short (S): 30 cm /11 ¾"	143 cm /56 ¼"	133 cm /52 ¾"
Medium (M): 60 cm /23 ⅝"	173 cm /68 ⅛"	163 cm /64 ⅛"
Long (L): 80 cm /31 ½"	193 cm /76"	183 cm /72"
Extra Long (XL) 100 cm /39 ¾"	213 cm /83 ⅞"	203 cm /79 ⅞"

Recommended Bolts		
Class	Diameter	Core Section mm ²
ISO 8.8	M 8X1.25	36.6
ISO 8.8	M 8X1	39.2
SAE- Grade 5	5/16" – 18 UNC	33.8
SAE- Grade 5	5/16 –24 UNF	37.41

WARNING



Risk of falling over



INSUFFICIENT WALL OR HARDWARE STRENGTH MAY CAUSE THE WALL ADAPTOR (WA) TO PULL OUT FROM THE WALL AND THE SYSTEM TO FALL OVER THE PATIENT OR THE OPERATOR CAUSING INJURIES.



Steel reinforcing plates are available to improve anchoring ability should the wall alone be not adequate.

Wall adaptor (WA) mounting options

The WA can be mounted with 1, 2, or 3 bolts at top, depending on wall quality, and with 1, 2, or 3 bolts at bottom.

- A. Two bolts only (top and bottom central holes – T2, B2) are used on a solid slim column (e.g. steel mounting studs) with weak sides (e.g. wooden wall). The top bolt has to withstand a load of 6000 N, comprehensive of the safety factor, i.e. about 1350 lbf or 612 kgf. Proper screw to be selected for a solid connection to the wall. Classes ISO 8.8 (M 8, M 8x1, M 8x1.25) or SAE Grade 5 (5/16" 18UNC, 5/16" 24 UNF) are recommended.
- B. Two bolts at top sides (T1, T3) and one or two at bottom (B1, B2, B3) is the regular mounting for solid wall (concrete). Each bolt at top has to withstand a load of 3000 N, comprehensive of the safety factor, i.e. about 675 lbf or 306 kgf. On solid concrete use heavy duty metal anchors. On hollow bricks use injection chemical fixing.
- C. Three bolts at top (T1, T2, T3) and one or two at bottom (B1, B2, B3) are required when the wall is not solid enough and the load has to be distributed on more points. Each bolt at top has to withstand a load of 2000 N, comprehensive of the safety factor, i.e. about 450 lbf or 204 kgf.



In case the wall is not in condition to withstand the indicated load, corrective actions can be evaluated by adoption of reinforcing plates:

- D. Large plate to fit vertical supports at 16-20" distance, with 4 mounting holes and one cable opening for the wall mount in the middle.
- E. In case of a thin (wooden) wall not solid enough, the use of a reinforcing steel counter plate 2 mm thick can be the solution.
- F. The use of two reinforcing steel plates of about 4 times the surface of the WA, one by each side of the wall, can help when a single plate is not adequate; additional bolts must be used to hold together the two plates.

5.3 Mounting system modules

5.3.1 Mounting the wall adaptor (WA)



Avoid-cutter label

- A. Open the packaging box paying attention not to damage the internal items.

 Risk of scratching plastic cover inside.

 Do not cut the "avoid-cutter" label. Turn the box and open on the other side.

- B. Take away the plastic cover removing the screw at bottom.

- C. Use the WA plate or the drill template to mark the fixing points.

The system control unit (SCU) can be mounted close to the WA at the right or left side or in a remote position with connecting cables laid out accordingly.

- D. Make the holes in the wall according to the applicable type of mounting with one, two, or three bolts at top, and those at bottom, with or without reinforcing plate. To be noted that the load is born by bolts at top.

- E. Mount the metal frame on the wall using proper heavy-duty anchors and make sure that the cables enter from behind SCU and WA.

- F. Secure it to the wall ensuring it is levelled with zero forward-backward and side deviations.

 Risk of unwanted arm drifting.

 Improper levelling of the mounting plate causes the arm to swing out of position.

 An uneven wall might require interposing thin inserts (like wide washers) at the fixing points at top or at bottom, between the wall and the mounting plate, to assure forward-backward verticality.



Put the level on the front to check for forward-backward deviations from verticality.



Put the level on the side to check for side deviations from verticality.

- G. Perform wire connection and final set-up complying with recommended sequence of actions reported in the following.

5.3.2 Mounting the system control unit (SCU)

WARNING

- A. Each SCU comes calibrated to work with a specific THA, the serial number of which is marked on a label placed on the plastic cover internally.
i If for some reason the serial numbers do not match, the SCU cannot be used as it is and needs to be calibrated as described at section 7.4, Replacement of the system control unit (SCU), at page 28.
- B. Use the mounting plate or the drill template to mark the holes on the wall.
- C. Take apart the control panel removing the screw at bottom.
i Pay attention when disconnecting the flat cable of the control panel from the power board.
- D. Drill the four holes in the wall and secure the SCU making sure it is levelled.
Cabling should have been laid out in accordance to mounting requirements.



5.3.3 Mounting the Support Arm (SA)

- A. Unpack the SA and check for integrity of parts.
- B. **i** Remove the rotation end-stop spacer but do not remove the string to pull the cable of the FA to the WA through the SA.
- C. Push back the cylinder of the friction not to interfere, lightly grease the shaft of the extension arm, avoiding to doing it in the middle part of the shaft where the brake is acting, and insert it into the WA.
- D. Mount the rotation end-stop spacer and close the lateral brake without tightening. Tuning of lateral brake to be done when the system is completely mounted.
- E. Verify 180° rotation from parking position at one side to the other side.

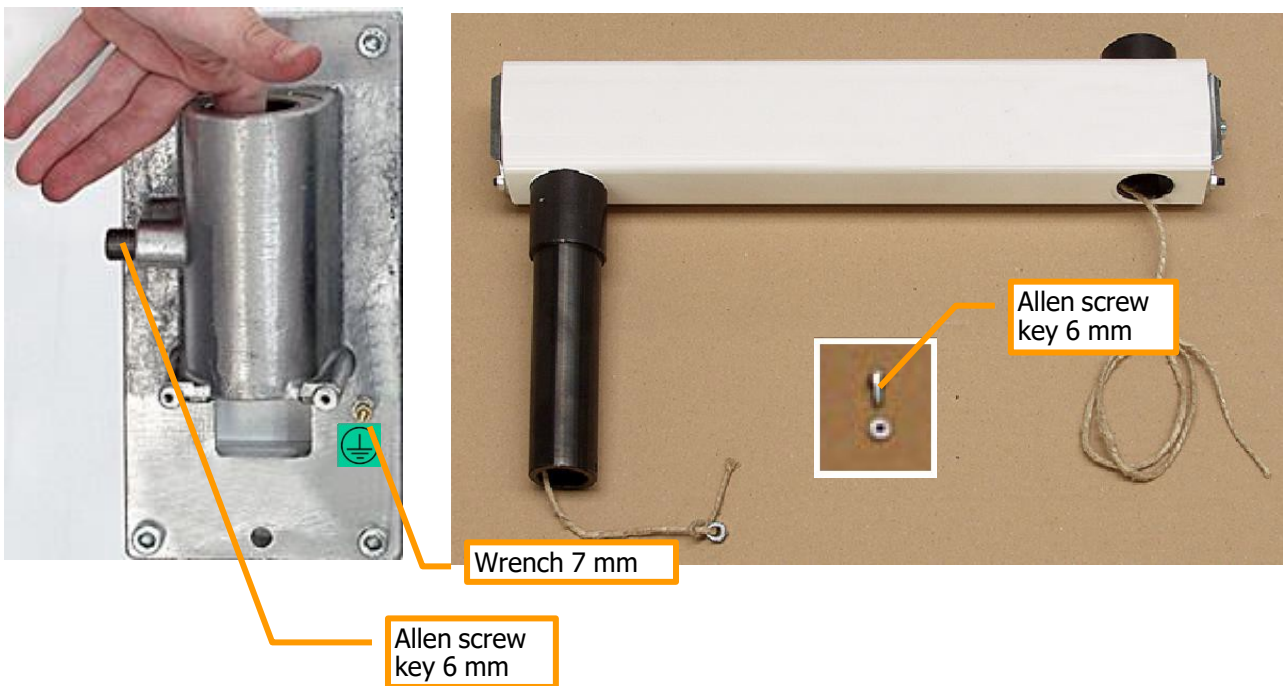

5.3.4 Mounting the Folding Arm (FA)

Handling

 Risk of injury.

 The compressed springs in the FA may cause injury to the installer as well as damage to the arm itself if the arm is not handled properly.

 Keep the security tape at the bottom of the arm to prevent sudden opening when operating without THA mounted and do not stay in front of the arm when it is being opened.

A. Light grease the shaft at the base of the arm avoiding to do it in the middle of the shaft where the brake is acting, and make sure the ring spacer is in place

B. Push back the cylinder of the brake into the SA not to interfere during the insertion of the shaft.



Allen screw
key 6 mm

C. Secure the trailing rope /string to the end of the cable of the FA.

D. Pull the other end of the trailing rope to drive the cable of the FA through the SA out into the WA.

E. Hold the opening section of the FA, carefully remove the safety string and allow the arm to open slowly, away from people.

F. Close the brake without tightening. The actual tuning of the brake to be done when the system is fully assembled.

G. Verify 330° rotation for wall systems.



5.3.5 Mounting the THA

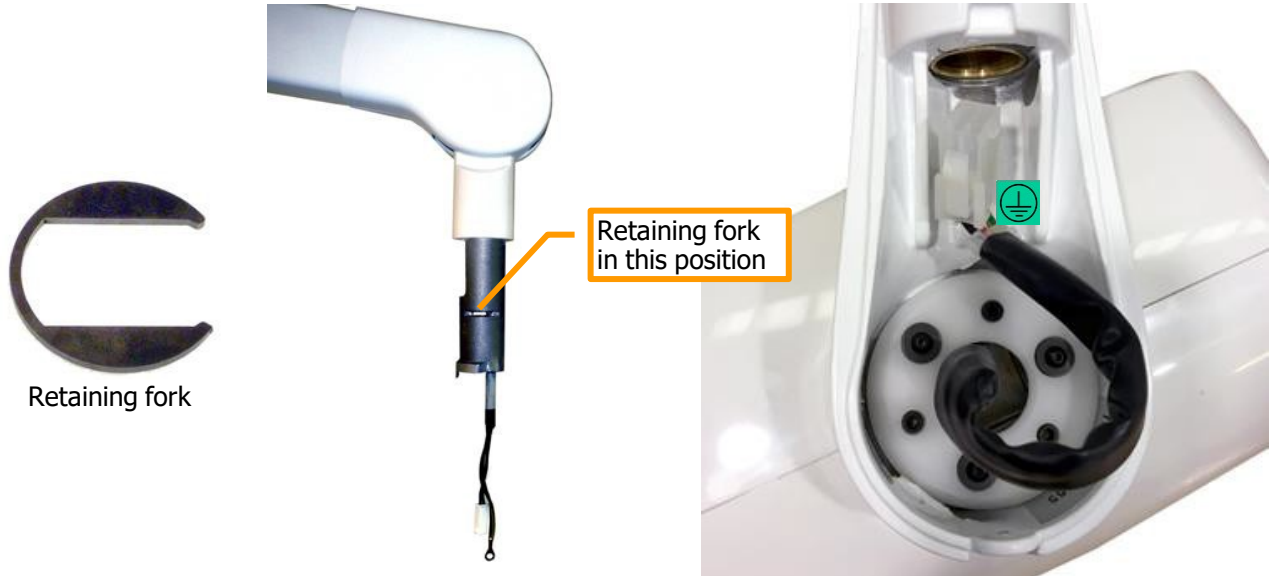

- A. Remove the retaining fork from the arm shaft.
- B. Remove the plastic cover from the yoke of the THA and slide it into the arm shaft passing the cable through, then hold it in place with the retaining fork.
- C. Verify smooth movement of the THA within limits without exceeding them:
 - a. 500° rotation of the THA around its vertical axis.
 - b. 340° rotation of the THA around its horizontal axis
- D. Tune the brakes for desired friction, in case.
- E. Put back the plastic cover of the yoke and screw it at bottom.

5.3.6 Mounting the beam limiting device (BLD)

The unit comes with default circular BLD 5.8 cm (2 1/4") diameter, featuring 20 cm (8") source skin distance (SSD). The following options can be mounted:

- A. 10 cm cone extension to reach 30 cm (12") SSD, featuring BLD with circular output field of 5.8 cm (2 1/4") diameter.
- B. Rectangular BLD to film size 2 (adult) of 3.2 x 4.4 cm (1 1/4" x 1 3/4") to be inserted into the circular BLD and working both at 20 cm (8") or at 30 cm (12") SSD.
- C. Rectangular BLD to film size 0 (pedo) of 2.2 x 3.2 cm (7/8" x 1 1/4") to be inserted into the circular BLD and working both at 20 cm (8") or at 30 cm (12") SSD.



5.4 Connecting system modules

5.4.1 Connecting the cable in the joint of the THA

- A. Make the connections in the joint of the THA.
 - a. Fix to the PE point with lock-washer and nut the earth provisions.
 - b. Attach the power supply connectors together.

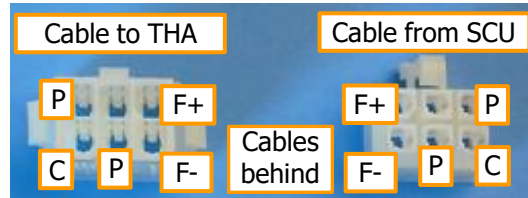

5.4.2 Connecting SA to PE point

- A. Make sure the earth provision for the WA is in place properly tightened with lock-washer and nut on the common bolt for PE bonding.
- B. Connect the earth provision of the SA to the common bolt for PE bonding on the WA and block it in place with lock-washer and nut.

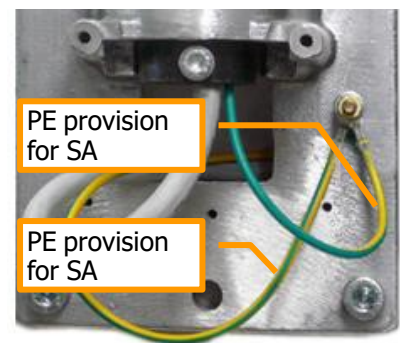

5.4.3 Connecting output cables to SCU

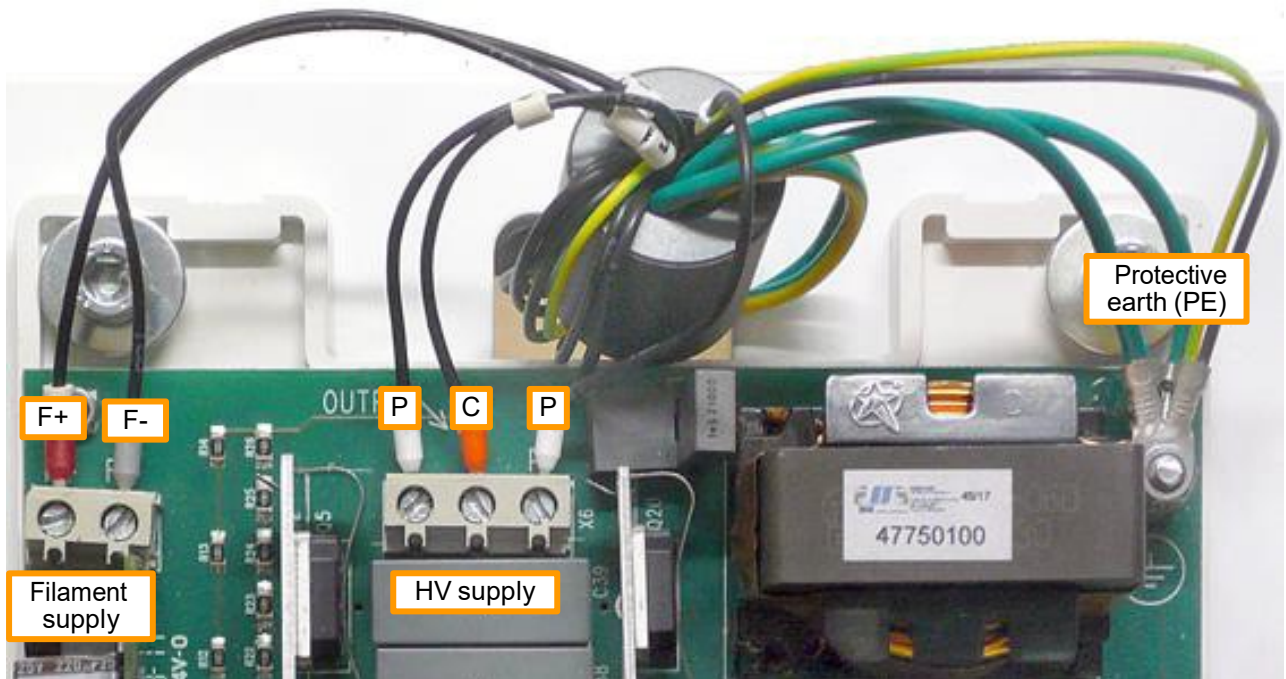

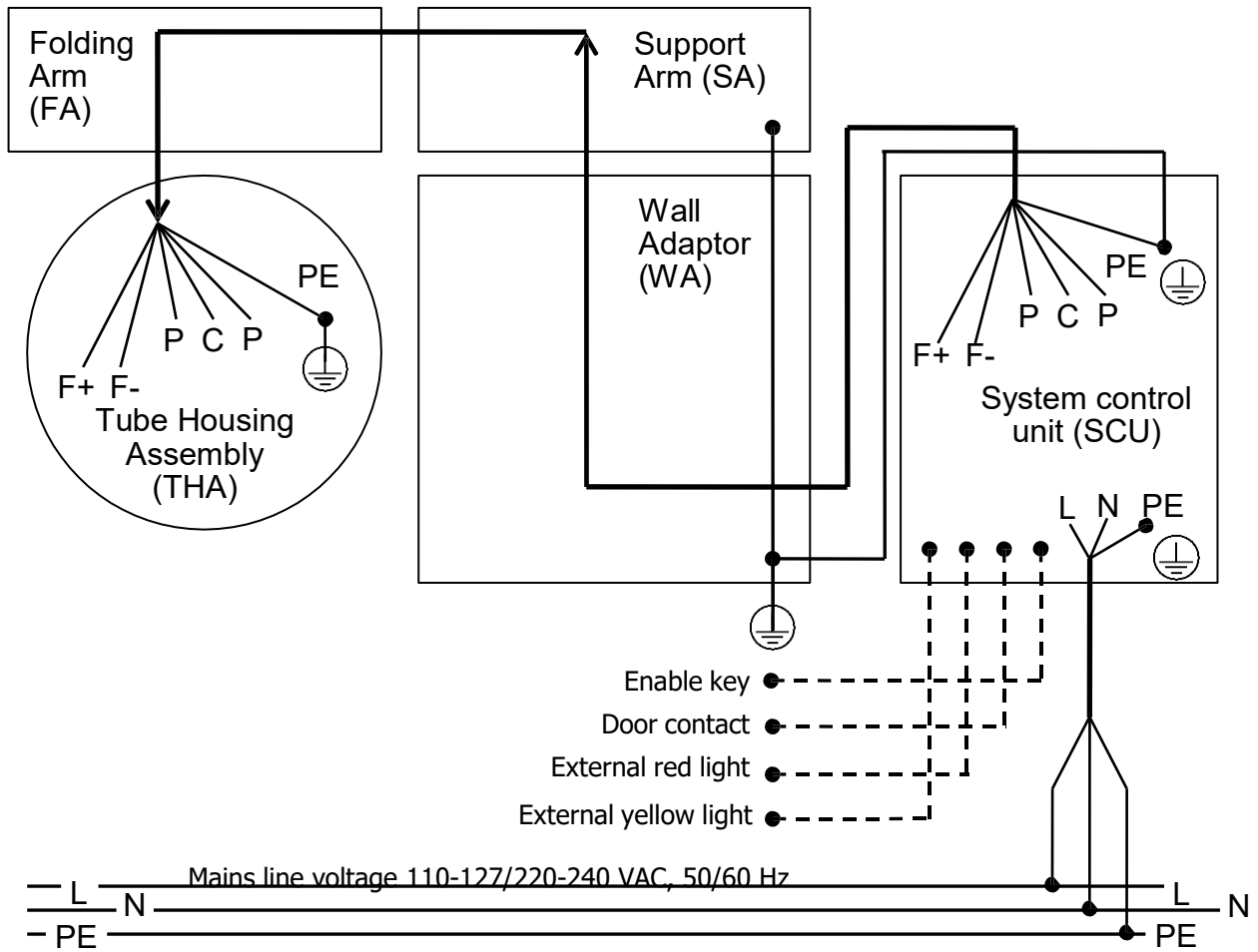

Wiring

A. Pass the power and earthing wires from the back of the WA to the back of the SCU for electrical connection at the top of it.

Fitting the ferrite bead

B. Fit the large ferrite bead on the set of conductors for filament and high voltage supply and earth provisions for THA and WA.
 a. Perform one loop through the centre of the ferrite bead with all conductors.

Connecting the output conductors

C. Connect all the conductors of earth provisions to the common bolt (PE point) at top right on the power driver board.
 D. Connect the filament supply conductors to the 2-position block at top left of the power driver board, to the respective positions, F+ to the left, F- to the right.
 E. Connect the HV supply conductors to the 3-position block at top center of the power driver board: the conductor marked C in center and those marked P at the sides.

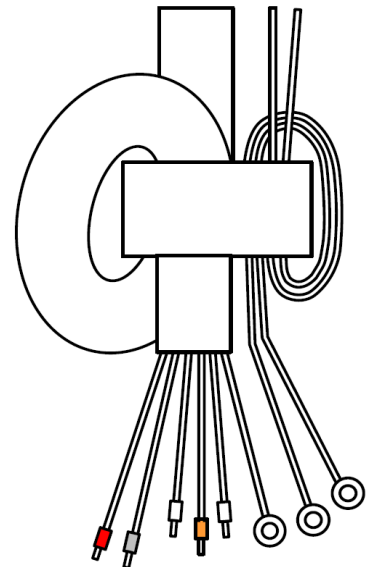

5.4.4 Connecting the X-ray THA to a distant SCU

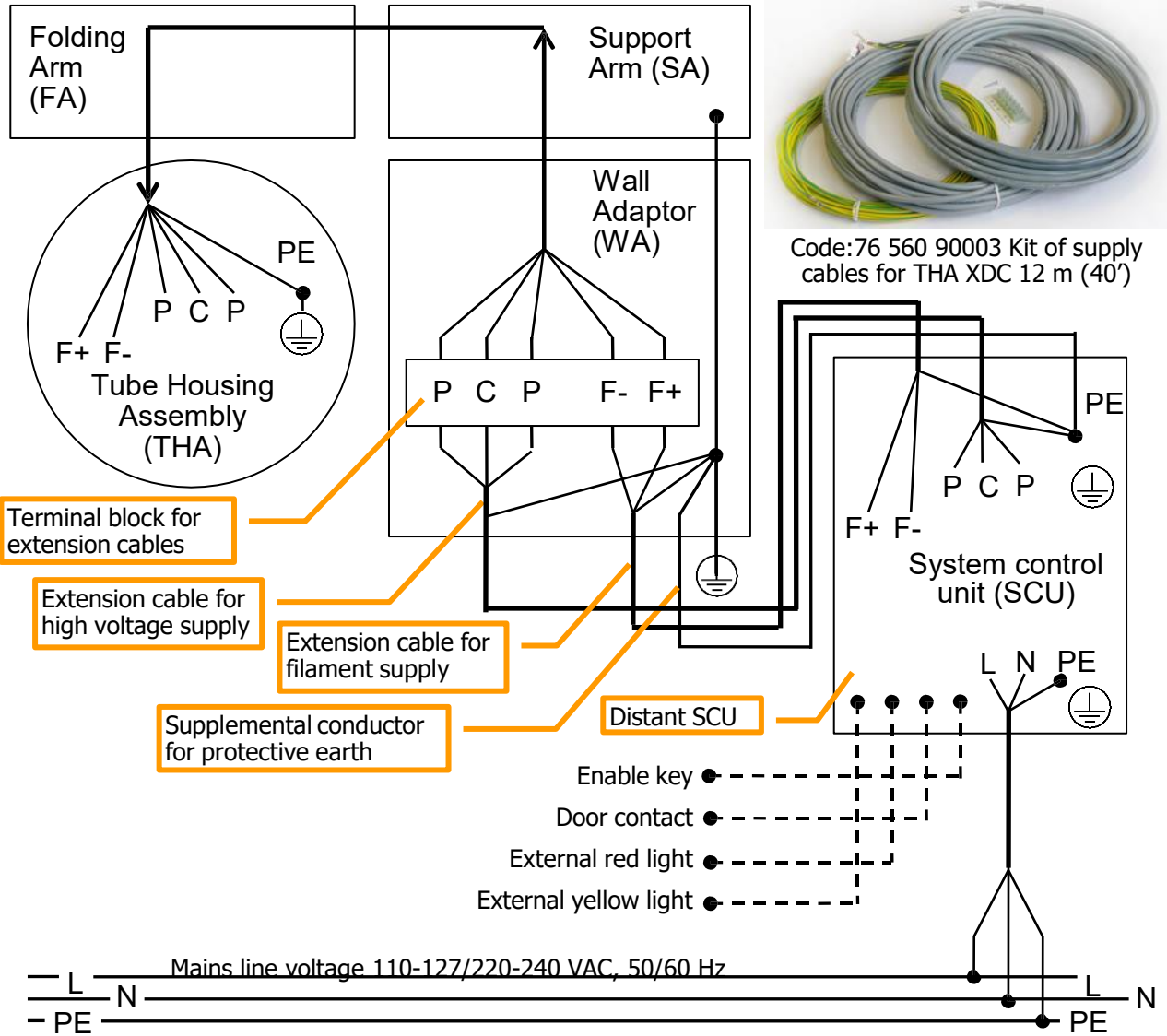

Wiring

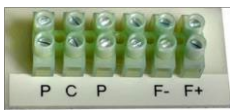

Preparation

Connecting long extension cables

- A. Use the kit of 12 m (40') supply cables for THA, code 76 560 90003:
 - a. Cable for HV supply: 12 m maximum 3-wire AWG18 shielded cable.
 - b. Cable for filament supply: 12 m maximum 3-wire AWG18 cable unshielded.
 - c. Conductor for PE connection: 12 m AWG13 green-and-yellow wire.
 - d. 6-position terminal block, label and screws to fix the block to the WA.
- B. Pass the extension cables and the long earthing conductor through the wall from the WA to the SCU placed far away. Cables terminations with longer wires go connected to the SCU and provide room for a ferrite bead.
- C. In the WA:
 - a. Remove the short green-and-yellow conductor from to the common bolt in the WA which must be replaced by the long one to reach the distant SCU.
 - b. Fix to the metal frame the 6-position termination block with relevant label.
- D. In the WA:
 - a. Fix with lock-washer and nut to the common bolt the three PE provisions of the two extension cables and of the long green-and-yellow conductor.
 - b. Connect to the P-C-P points of the block the three conductors of the extension cable for HV supply at one side and to the other side the corresponding P-C-P conductors of the cable to the THA.
 - c. Connect to the F+ and F- points of the block the two conductors of the extension cable for filament supply at one side and to the other side the corresponding F+ and F- conductors of the cable to the THA.
- E. Proceed now as per connection when SCU is close to the WA, as described in the previous section.

5.4.5 Connecting the X-ray hand-switch

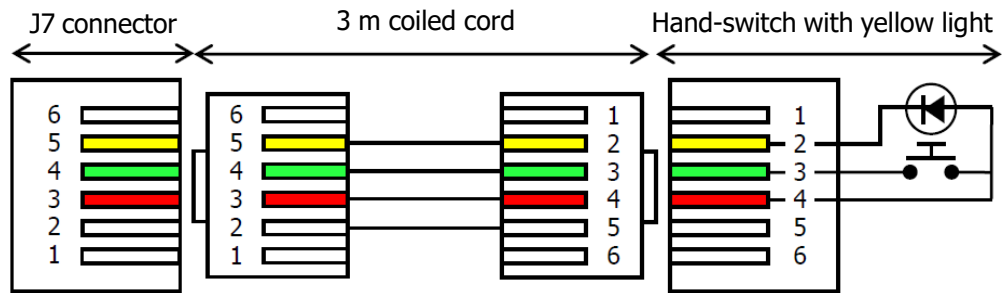

- A. The hand-switch is provided with a 3 m coiled cord with two terminations to be plugged in the body of the hand-switch and in the connector J7 at bottom of power driver board, part of the system control unit (SCU).

5.5 Optional connections

5.5.1 Connecting the X-ray hand-switch remote and key lock

Hand-switch remote with yellow light (3-wire connection)

- A. In order to place the X-ray hand-switch with yellow warning light at distance, a 3-wire connection has to be made to J1 plug into the SCU (timer).
 - a. Via J1 connector on the filament board, with a 10 m cable with RJ11 plug on one side and free termination on the other side.
 - b. Wire the 10 m cable to the termination block in the remote box.
 - c. Plug the hand-switch with coiled cord to the RJ11 connector in the box.

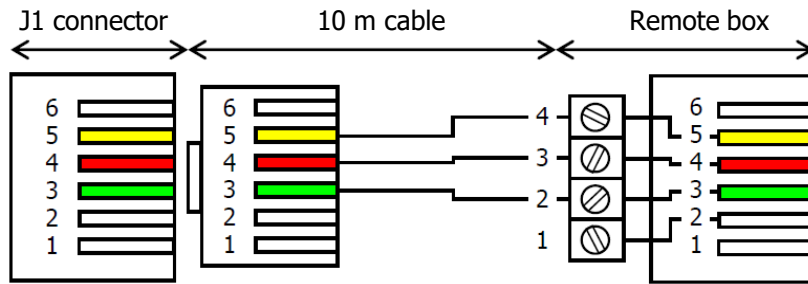

Hand-switch remote without yellow light (2-wire connection)

- B. 2-wire remote X-ray hand-switch:

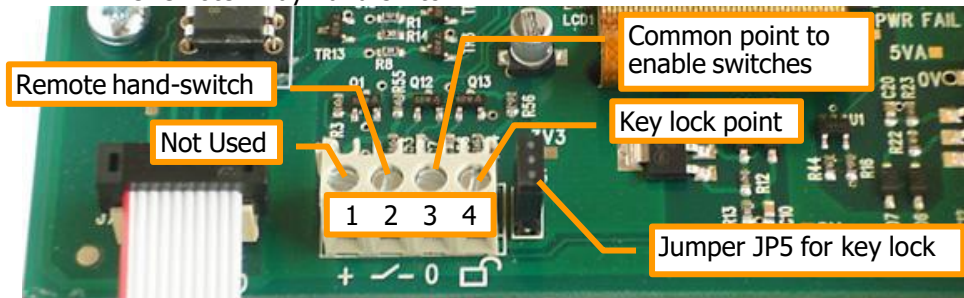

- a. Connect the 2-wire remote hand-switch to the terminal block on the control unit board, position 2 (switch symbol) and position 3 (common point).

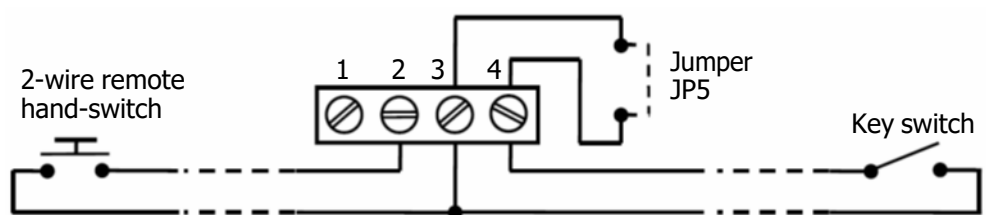

Enable Key

- C. A key lock to enable and disable the use of the system can be connected to the terminal block on the control unit board.
 - a. Connect the key lock switch to the terminal block on the control unit board, position 4 (key lock symbol) and position 3 (common point).
 - b. Remove jumper JP5 to activate the key lock functionality.

5.5.2 Activation of door contact and additional enable

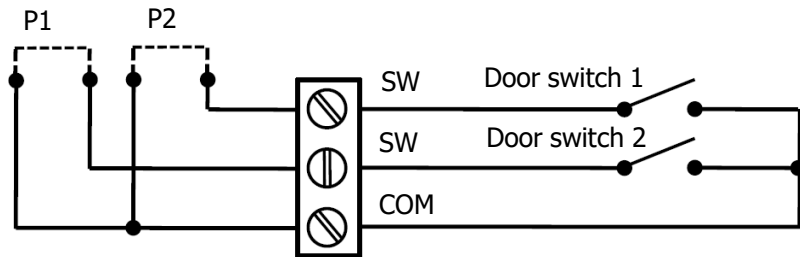
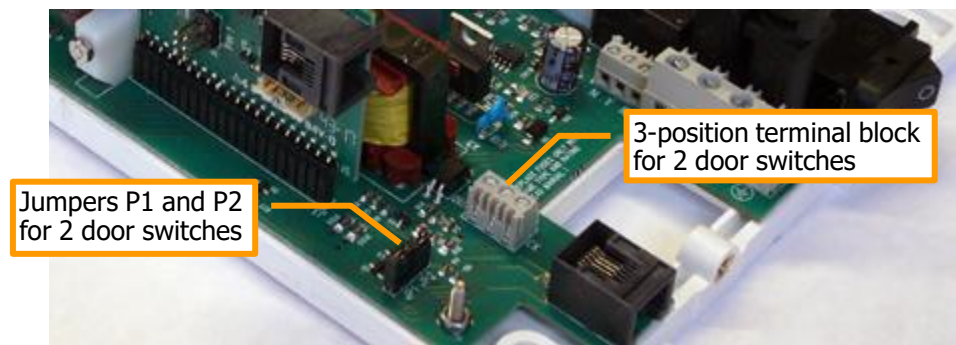

- A. A 3-position terminal block is available on the power driver board (part of the SCU) for connection of up to two door contacts (SW to COM), to prevent irradiation with a door open.
 - a. The unit is provided with two jumpers P1 and P2 in place which must be removed to connect the two door contacts, and, conversely, they must stay in place if the two door contacts are not used.
 - b. Use one position for a single door contact.
 - c. The second contact can be used as additional enable for safety reasons.

5.5.3 Activation of warning lights

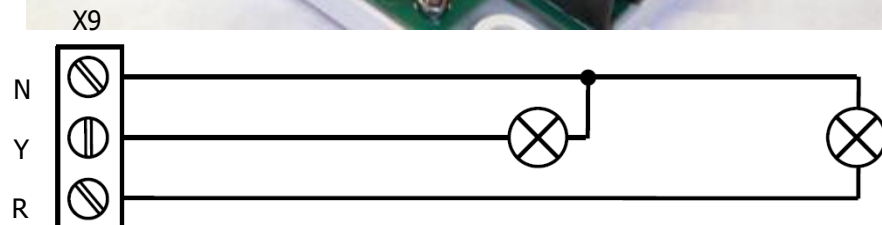
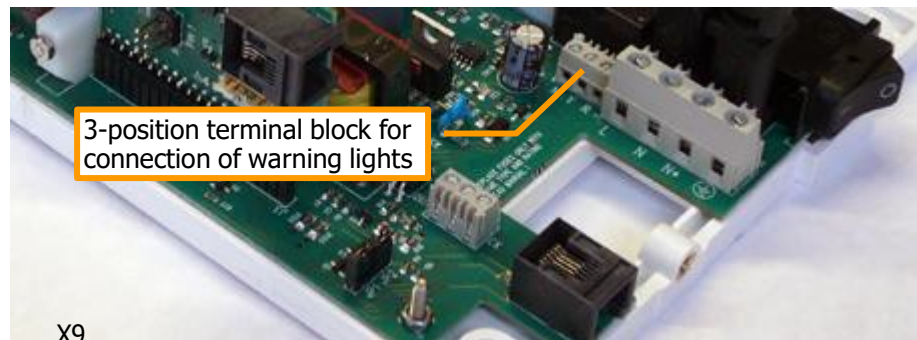

- A. A 3-position terminal block is provided to connect two light bulbs working at the applicable mains voltage.
 - a. Each light bulb of 50 W maximum.
 - b. The red warning light signaling that the radiological equipment has been turned on, must be connected to the N and R points.
 - c. The yellow warning light signaling that irradiation is in progress, must be connected to the N and Y points.

5.6 Connection to mains power supply

5.6.1 Configuring SCU for mains power supply

- A. The SCU is a dual voltage equipment which can be set to work either in the range from 110 to 127 V or in the range from 220 to 240 V, at 50 or 60 Hz.
- B. Before connection to the mains line the SCU must be configured according to the applicable voltage level as indicated in the two columns of the following table.

220-240 V 50/60 Hz Fuses T 5AH 250 V

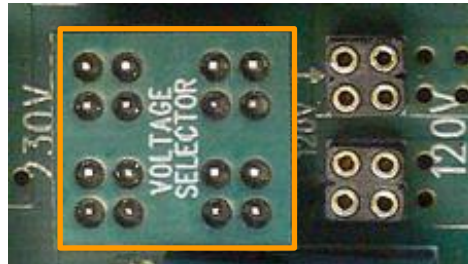

- Plug the mains voltage selector on the LEFT side for 220-240 V mains.
- Mount fuses T 5AH, 250 V, 5x20.
 - Fuse F1 is acting on N* line
 - Fuse F2 is acting on L line.
- Tick the 220-240 V voltage box on the SCU label with permanent mark.

110-127 V 50/60 Hz Fuses T 8AL 250 V

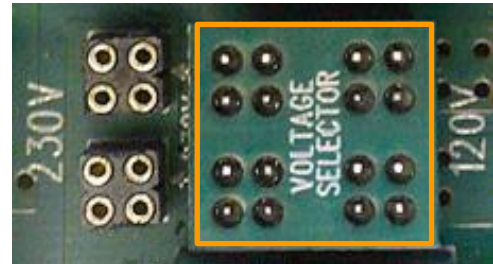

- Plug the mains voltage selector on the RIGHT side for 110-127 V mains.
- Mount fuses T 8AL, 250 V, 5x20.
 - Fuse F1 is acting on N* line
 - Fuse F2 is acting on L line.
- Tick the 110-127 V voltage box on the SCU label with permanent mark.

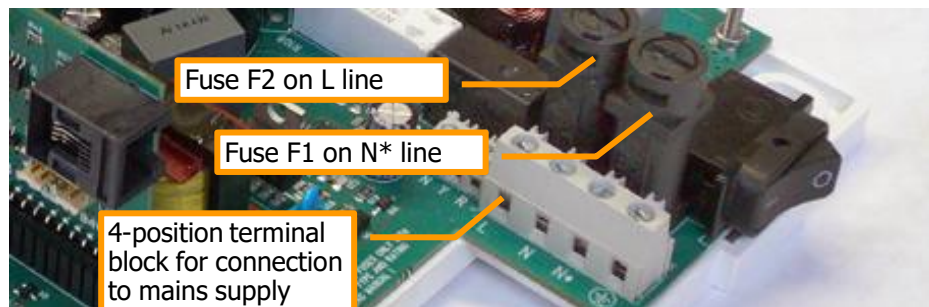

5.6.2 Connecting SCU to mains power supply

⚠ Risk of electrical shock **i** Turn "OFF" the mains voltage supply line of the room and of the SCU before operating.

Prepare the input conductors

- A. Two ferrite beads must be mounted on the power supply conductors.
 - a. Prepare the 3 input conductors to have 10 cm additional length for the live and neutral conductors, and 20 cm of the green-and-yellow of protective earth (PE) provision to accommodate for ferrite beads.
 - b. Make the 3 conductors of live, neutral, and PE to perform 1 loop trough the centre of the large ferrite bead, the PE conductor ending 10 cm longer.
 - c. Make the PE conductor to perform 1 additional loop through the centre of the small ferrite bead.

Placing ferrite beads

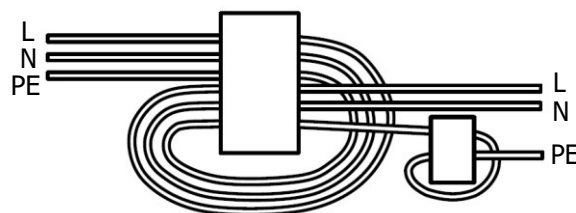

Mains connection possibilities

- B. Two possibilities of electrical connection are reported below:
 - a. 1-phase supply and permanent connection, when no plug is involved.
 - b. 2-phase supply or non-permanent connection with cord and plug.

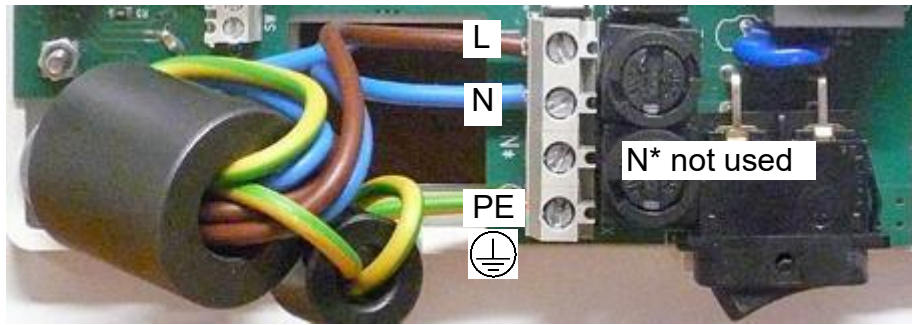

1-phase supply and permanent connection

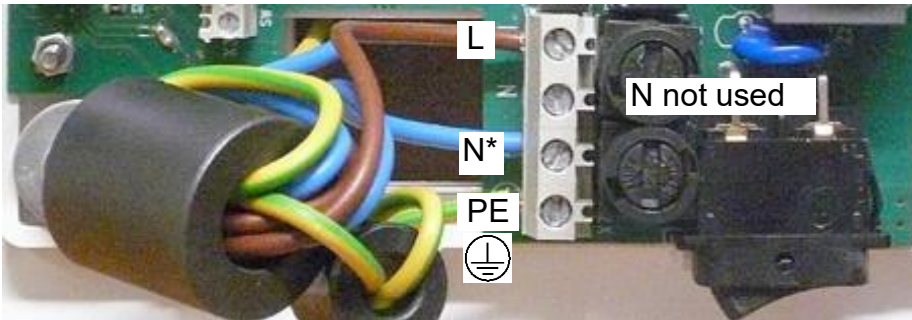

- C. Connect the mains line to the terminal block at bottom of the power driver board, part of the SCU:
 - a. The green-and-yellow conductor of earth provision to the PE point.
 - b. The live conductor to L point (input fused with F2).
 - c. The neutral conductor to the N point (input NOT fused).
 - d. The N* position is NOT used, so no conductor is applied.
- D. Make sure that the "live" conductor is the "hot" one:
 - a. Turn ON the mains voltage supply of the room but do not turn ON the line voltage supply switch of the SCU.
 - b. If full line voltage is measured with an AC voltmeter between L and PE, the wiring is correct.
 - c. On the contrary, if full line voltage is NOT measured between L and PE, turn OFF the mains voltage supply of the room, reverse the connection of conductors at L and N points and repeat the measurement; eventually the full line voltage should be read between L and PE.
- E. Make sure no voltage is read between N and PE, and, if not, have the line voltage distribution checked.
- F. The connection to a 1-phase mains supply line has ended. Turn OFF the mains voltage supply of the room and group input conductors (see below).

2-phase supply or non-permanent connection



- G. Connect the mains line to the terminal block at bottom of the power driver board, part of the SCU:
 - a. The green-and-yellow conductor of earth provision to the PE point.
 - b. The live conductor to L point (input fused with F2).
 - c. The neutral conductor to the N* point (input fused with F1).
 - d. The N position is NOT used, so no conductor is applied.
- H. The 2-phase or NON-permanent connection to the mains supply line has ended. Turn OFF the mains voltage supply of the room and group input conductors.
- I.  Risk of accidental isolation loss.  Group the two supply leads together with self-locking nylon tie strip, also embracing conductors through the large ferrite, in to order to prevent a loosen conductor to move around.

2-phase supply or non-permanent connection

Group input conductors

5.7 Final system set-up

- A. Verify brakes and tune them, in case, as indicated in the maintenance section.
 - a. Brake in WA, SA, FA, and acting on THA.
- B. Mount back all plastic covers and enclosures if not yet done:
 - a. Cover of the WA, SCU, and yoke of THA fixing them with a screw at bottom.
 - b. Set of covers on the joints of the FA: place them in pairs.
- C. The unit is now ready for functional test.

6. Installation of mobile system

6.1 Mounting and connecting mobile system modules

6.1.1 Assembling the mobile stand

- A. Mount the legs under the central base.
- B. Mount the four wheels with brakes.
- C. Fix the pole carrying the supporting metal box for the SCU to the central base.
- D. Complete the stand with:
 - a. Pair of transport handles.
 - b. Pair of knobs to hang the power cord.
 - c. Spiral cable gland.



6.1.2 Mounting FA on mobile stand

- A. Loosen the screw of the brake for friction at top of the pole and push back the cylinder of the same, not to interfere during shaft insertion.
- B. Insert the shaft of the FA having passed the cable through the hole at the center of the metal box at the top of the pole of the mobile stand.
- C. Tighten the screw of the brake for desired friction.
- D. Verify 40° rotation within legs opening.



6.1.3 Mounting the THA

- A. Refer to the same procedure as for a wall mounted system, section 5.3.5 above, Mounting the THA, at page 16.

6.1.4 Mounting the BLD

- A. Refer to the same procedure as for a wall mounted system, section 5.3.6 above, Mounting the beam limiting device (BLD), at page 16.

6.1.5 Connecting the cable in the joint of THA

- A. Refer to the same procedure as for a wall mounted system, section 5.4.1 above, Connecting the cable in the joint of the THA, at page 17.

6.1.6 Preparing the mains supply cord

Mains plug

- A. Complete the mains voltage supply cord with a plug provided with earth connection. If feasible, use a plug where the connection to the protective earth is made before and interrupted after the supply connections are made or interrupted.

PE connection

- B. Verify proper connection of the green-and-yellow conductors to the common bolt at the center of the metal box:
 - a. In first position the incoming earth provision of the mains cable.
 - b. In second position the outgoing earth provision to the SCU.

6.1.7 Mounting SCU on mobile stand

- A. Detach the control panel from the SCU by removing the screw at bottom and disconnect the flat cable from the filament calibration board, at the side.
- B. Wind the and collect in the mounting box the excess of cables to the THA, blocking them with a self-locking nylon tie strip, and letting the long terminations to exit at top ready for the mounting of the ferrite beard and later connection.
- C. Let the conductors of the mains supply cord exiting the hole at bottom, ready for the mounting of the ferrite beard and later connection.
- D. Fasten the SCU to the metal box with four screws at the corners.

6.1.8 Connecting output cables to SCU

These connections are similar to those of a wall system.

Fitting the ferrite bead

- A. A large ferrite bead must be fitted to the output conductors before their connection. For detailed instructions refer to section 5.4.3, Connecting output cables to SCU, at page 17.

Connecting the output conductors

- B. Perform electrical connections of output cables, referring for detailed instructions to section 5.4.3, Connecting output cables to SCU, at page 17. Consider:
 - a. PE provisions.
 - b. Output conductors for filament supply (marked F+ and F-).
 - c. Output conductors for HV supply (marked P-C-P).

6.1.9 Connecting the X-ray hand-switch



- A. Same connection as per a wall system. For detailed instructions refer to section 5.4.5, Connecting the X-ray hand-switch, at page 20.

6.1.10 Configuring SCU for mains power supply

- B. Same procedure as per a wall system. For detailed instructions refer to section, 5.6.1, Configuring SCU for mains power supply, at page 22.

6.1.11 Connecting SCU to mains power supply

Safety aspects

 Risk of electrical safety level degradation.  Units provided with supply cord and plug must be equipped with fuses on each supply lead.

- A. Mobile units are provided with supply cord and as such are NOT permanently connected. Therefore refer to applicable parts listed below, described in section 5.6.2, Connecting SCU to mains power supply, at page 22:
 - a. Place ferrite beads.
 - b. Perform non-permanent or 2-phase connection, using, besides PE, the L and N* positions (both fused), thus skipping the N position (NOT fused) which must NOT be used in this case.
 - c. Group input conductors.

2-phase supply or non-permanent connection

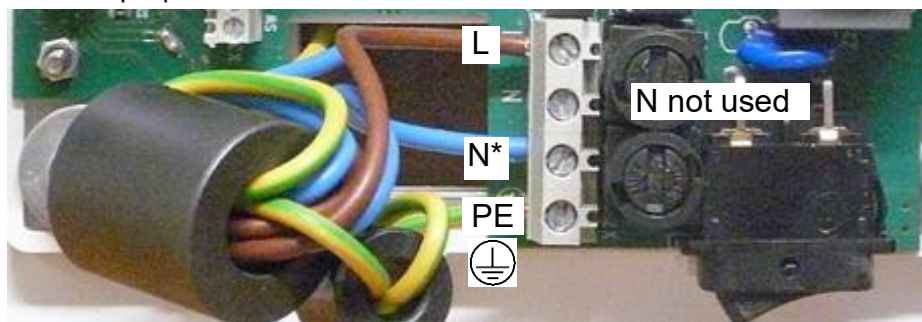

6.1.12 Final system set-Up

Refer to the applicable points of procedure as describe for a wall system, section 5.7, Final system set-up, at page 23.

7. Service

7.1 Line fuses

Safety aspects

 Risk of electrical shock.

 Do not replace a blown fuse. The fuse is a protection device whose intervention by its interruption indicates that a malfunction has occurred.

Such a malfunction must be removed before operating the unit again.

Activating a defective unit by replacing a blown fuse can be dangerous due to the high of voltage and energy levels involved.

- A. The two fuses F1 and F2 must not be replaced in field.
 - a. In case a fuse blows, the power driver board is likely to be out of order and must be replaced with a good one.
 - b. Arrangement must be made with the service technician and the manufacturer to return the board for repair or to procure new one.

7.2 THA test JIG

- A. A tool is provided for the measurement of the anode current and of the filament voltage using a DC voltmeter. The test JIG is mounted in the joint of the THA on the connectors of the supply cable.
 - a. The point F- is at ground level and is used as a reference also for the voltage indicating the anode current.
 - b. The anode current in mA is measured by reading the DC voltage between mA and F- on a 1000 Ohm resistor mounted into the THA. 1 V corresponds to 1 mA. 7 V measured thus indicate 7 mA of anode current.
 - c. The filament supply voltage, of about 4 V, is measured between F+ and F-.

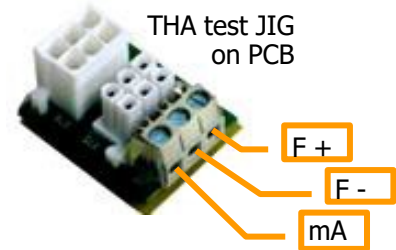
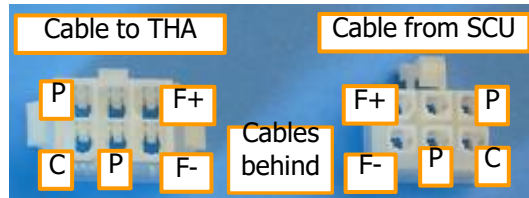
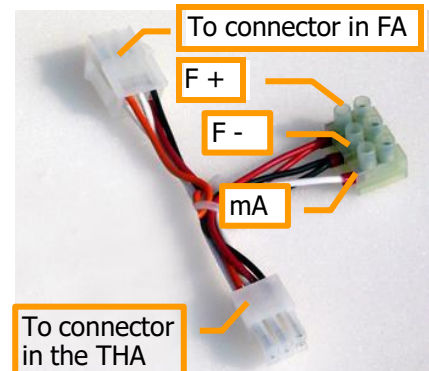



7.3 Replacement of X-ray THA

WARNING

 Risk of injury. The compressed springs in the FA may cause injury to the installer and damages to the arm itself if not handled properly.

 Use a security tape to tie the FA at the bottom to prevent its sudden opening when operating without THA mounted and do not stay in front of the arm when it is unfolded.

 Risk of operator exposure to radiation.

 Move at least at 2 m from the source, out of the path of the X-ray beam, to avoid radiation.



Instrumentation

- A. Required to perform proper tuning of the unit:
 - a. Multi-meter for DC voltage measurement, 10 V end of scale.
 - b. Non-invasive kV meter.

c. THA test JIG.



- B. Turn OFF power supply.
- C. Position the FA open, remove the plastic cover from the joint, detach the cable connectors from each other and unscrew the earth conductor.
- D. Hold the THA while removing the holding fork, then take it apart letting the connector of the cable sliding through the mounting pipe.
- E. Take the new THA, pass the cable's connector through the mounting pipe, push it up and set it in place with the holding fork.
- F. Fix the earth conductors to the protective earth (PE) point.
- G. It is assumed the new association of SCU and THA requires tuning of SCU for filament and high voltage calibrations, so the THA test JIG must be plugged-in for the necessary measurements.
- H. Connect a multi-meter for DC voltage measurement, 10 V DC end of scale, between F- and mA points of the THA test JIG.
- I. Place the non-invasive kV meter at about 50 cm (19 5/8") in front of the output beam ready to measure the kV level.
- J. Turn ON power supply.
- K. The tuning at 70 kV must be done first. Perform X-ray exposures at 70 kV, 7 mAs (1 s at 7 mA) or more:
 - a. Verify that the measured kV level is ranging from 66.5 to 73.5 kV. If not, tune the HV CALIBRATION TRIMMER R56 to have a value in the indicated range: turn it clockwise to reduce the kV level or counter-clockwise to increase it.
 - b. Verify that the measured voltage at the mA point is from 6.3 to 7.7 V DC, 1 V corresponding to 1 mA of anode current. If not, tune the trimmer R104 to fall in the indicated range: turn it clockwise to increase the current or counter-clockwise to reduce it.
- L. The tuning at 60 kV has to be done next. Perform X-ray exposures at 60 kV, 7 mAs (1 s at 7 mA) or more:
 - a. Verify that the measured kV level is ranging from 57 to 63 kV. If not, tune the HV CALIBRATION TRIMMER R56 to have a value in the indicated range: turn it clockwise to reduce the kV level or counter-clockwise to increase it.
 - b. Verify that the measured voltage at the mA point is from 6.3 to 7.7 V DC, 1 V corresponding to 1 mA of anode current. If not, tune the trimmer R129 to fall in the indicated range: turn it clockwise to increase the current or counter-clockwise to reduce it.
- M. Terminate the procedure when the values are in the stated ranges.
- N. Turn OFF power supply.
- O. In case it is not possible to calibrate the unit with values in the specified ranges put the unit out of service and call for technical assistance.
- P. Disconnect the THA test JIG and connect the supply cable in the FA to the THA directly.
- Q. Perform an exposure to verify proper connection.
 - a. Turn ON power supply.
 - b. Expose to check
 - c. Turn OFF power supply.
- R. The replacement of the X-ray THA is terminated.

Mounting new THA



THA test JIG

Preparation

Calibration of anode voltage and anode current at 70 kV

kV  R56
 mA  R104

Calibration of anode voltage and anode current at 60 kV

kV  R56
 mA  R129

Termination

Non-compliance

End of X-ray THA replacement

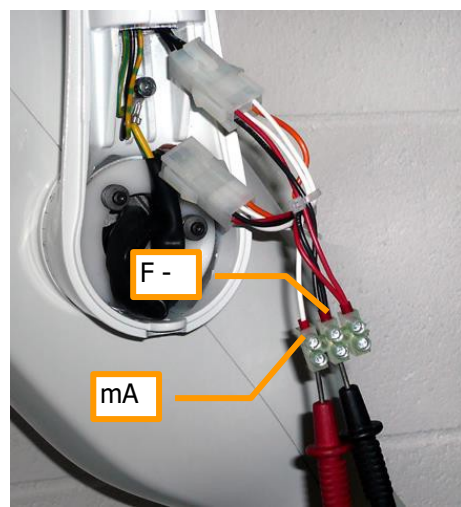

7.4 Replacement of the system control unit (SCU)

WARNING



Risk of operator exposure to radiation.  During testing with radiation move at least at 2 m from the source, out of the path of the X-ray beam, and avoid direct exposure.

Instrumentation

- A. Instrumentation required to perform proper tuning of the unit
 - a. Multi-meter for DC voltage measurement, 10 V end of scale.
 - b. Non-invasive kV meter.
 - c. THA test JIG.

Mounting a new SCU

- B. Turn OFF power supply.
- C. Remove the cover of the SCU having also disconnected the flat cable from the filament calibration board.
- D. Disconnect the mains cable and its earth wire then the output cable for filament and HV supply and its earth wire.
- E. Dismount the board from the back frame and mount the new one.
- F. Connect the output conductors for filament and high voltage supply plus the earth wires (to the protective earth point) at top and the mains cable and its earth wire (to the protective earth point) at bottom.
- G. Connect the flat cable from the control unit board to the relevant connector on the filament calibration board, then close it.

THA test JIG

- H. It is assumed the new association of SCU and THA requires tuning of SCU for filament and high voltage calibrations, so the THA test JIG must be plugged-in for the necessary measurements.
- I. The actual calibration activities from preparation to termination are the same described for the replacement of the THA so, for details, please refer to section 7.3, Replacement of X-ray THA, at page 26.
- J. Turn OFF power supply.

Non-compliance



- K. In case it is not possible to calibrate the unit with values in the specified ranges put the unit out of service and call for technical assistance.

End of replacement of the SCU

- L. Remove the THA test JIG and connect the cable in the FA to the THA directly.
- M. Put back the plastic cover on the THA joint and close the SCU.
- N. Perform an exposure to verify proper connection.
 - a. Turn ON power supply.
 - b. Make a short exposure to check.
 - c. Turn OFF power supply.
- O. The replacement of the SCU is terminated.

7.5 Exchange of power driver board

WARNING

 Risk of operator exposure to radiation.  During testing with radiation move at least at 2 m from the source, out of the path of the X-ray beam, and avoid direct exposure.

Exchange of power driver board

- A. A power driver module with a defective power driver board and a good filament calibration board, already tuned for the involved THA, can be fixed with the bare replacement of the power driver board. The existing filament calibration board (with mA trimmers R104 and R129 properly tuned) can in fact be mounted on the new power driver board where the trimmer R56 for HV regulation will be tuned to the right value, as originally set on the replaced board.

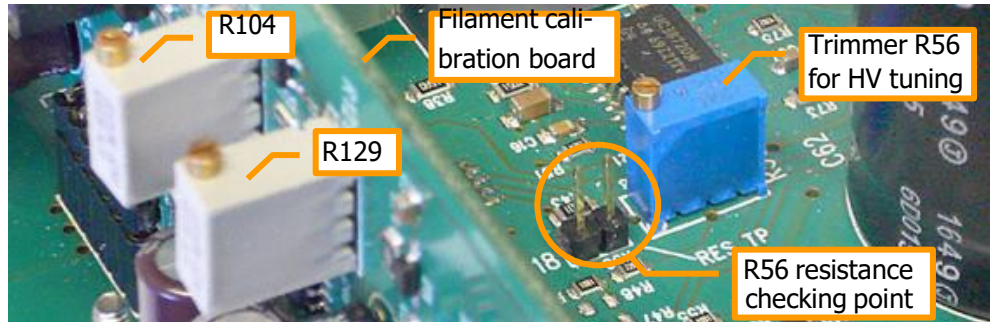

Instrumentation

- B. Instrumentation required to perform proper tuning of the unit
- Meter for measurement of electric resistance.
 - THA test JIG.

Dismounting the defective board

- C. Turn power supply OFF.
- D. Take apart the control panel of the SCU.
- E. As a preparation for the board exchange:
- Perform the measurement of the resistance of trimmer R56 at the check points on the defective board and annotate it (up to 2 kOhm).
 - Annotate the point of connection of the neutral conductor to replicate it, whether N, without fuse, for 1-phase supply or permanent connection, or N*, with fuse, for non-permanent or 2-phase connection.
- F. Disconnect the mains supply conductors. No need to remove the ferrite beads.
- G. Disconnect the output power cables for filament and high voltage supply and the earth provisions from the common bolt at top on the power driver board. No need to remove the ferrite bead from the cables.
- H. Dismount the power driver board from the mounting frame.
- I. Dismount the filament calibration board from the power driver board unscrewing it from the back.

Mounting a new SCU

- J. Mount the filament calibration board on the new power driver board and block it in place with the screw on the back.
- K. Mount the new power driver board complete with filament calibration board on the supporting frame and block it in place with lock-washers and nuts.
- L. Tune the R56 trimmer, while measuring its resistance at the test points, to reach the same value as measured on the former board.
- M. Connect the output conductors, complete with ferrite bead, for filament and high voltage supply, plus the earth wires, at top. For details refer to section 5.4.3, Connecting output cables to SCU, at page 17.
- N. Connect the mains supply conductors, already fitted with ferrites, to the input block as described in section 5.6.2, Connecting SCU to mains power supply, at page 22, paying attention to realize the same type of connection as previously in place, with neutral conductor connected to N point for a "permanent" connection or to N* for a "non-permanent" one.
- O. Reconnect the flat cable from the control unit board to the filament calibration board, then place the cover with control panel.
- P. Perform an exposure to verify proper connection.
- Turn power supply ON.
 - Make a short exposure to check.
 - Turn power supply OFF.
- Q. The exchange of the power driver board is terminated.

7.6 Replacement of mains supply cord

Introduction

A. The mains supply cord, which is used on the mobile unit, is a three-core cable size AWG16 for mains connection.

Removing old cord

- B. Make sure the plug of the supply cord is not connected to the mains line.
 C. Remove the control panel to have access to the mains connection block.
 D. Disconnect the mains supply conductors of the existing cable from the termination block and remove the ferrite beads from them.
 E. Remove the bolts at corners holding the SCU in place and raise it to have access to the common bolt for PE connection in the frame behind.
 F. Disconnect the green-and-yellow conductors bonded there:
- The one for the earthing of the SCU.
 - The earth provision from the mains line, which is placed first.

G. Unscrew the gland with spiral tail from the pole.

H. Pull out the old cable from the pole having attached to it a leading rope to prepare to pull the new cable in.

Mounting new cord

I. Pull the new cord in the gland with spiral tail, then into the pole and eventually tighten the gland to block the power cord.

J. Strip the cable sheath to free the internal wires for 20 cm and terminate the green-and-yellow conductor of PE provision with a 4 mm ring.

K. Connect the green-and-yellow conductors to the common bolt in the metal frame.

- Place first the earth provision from the mains line and block it in place with lock-washer and nut.
- Place in second position the earth provision of the SCU, blocking it in place with lock-washer and nut.

L. Pass the mains supply conductors of the power cord and the earth provision into the square hole of the supporting plate and fix the same plate to the frame box.

Placing ferrite beads

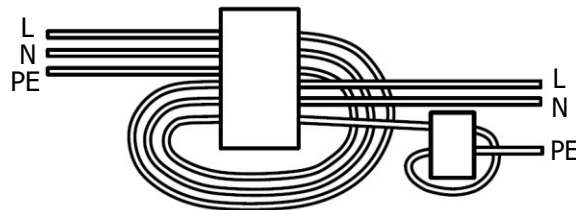

M. Considering that equipment provided with power cord and plug require a non-permanent connection, fuses must be on both power supply conductors, thus L and N* positions must be used for connection to the input block.
 For detailed instructions refer to section 5.6.2, Connecting SCU to mains power supply, at page 22 and following, considering the applicable parts listed below.

- Place ferrite beads.
- Perform non-permanent or 2-phase connection, using, besides PE, L and N* (both fused), thus avoiding N (NOT fused) in this case.
- Group input conductors.

2-phase supply or non-permanent connection

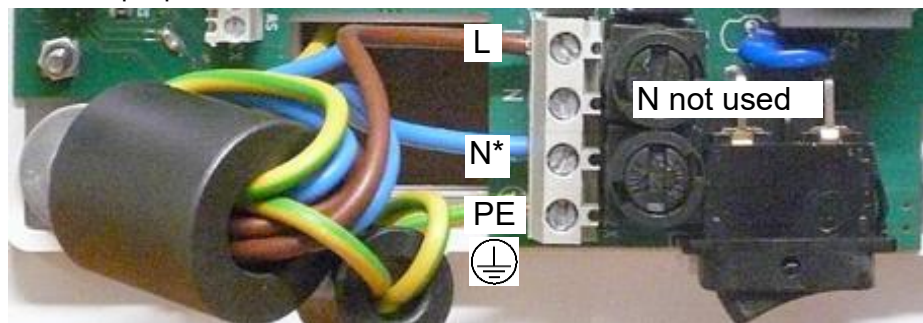

- N. Mount back the control panel of the SCU.
 O. Complete the mains supply cord with proper plug.
 P. The replacement of the mains supply cord is terminated.

8. Maintenance

Safety degradation

Report any defect detected.

 Risk safety degradation

 In presence of defects which may constitute a safety hazard to the patient as well as to the operator do not use the unit until repairs are made.

8.1 Checking labels

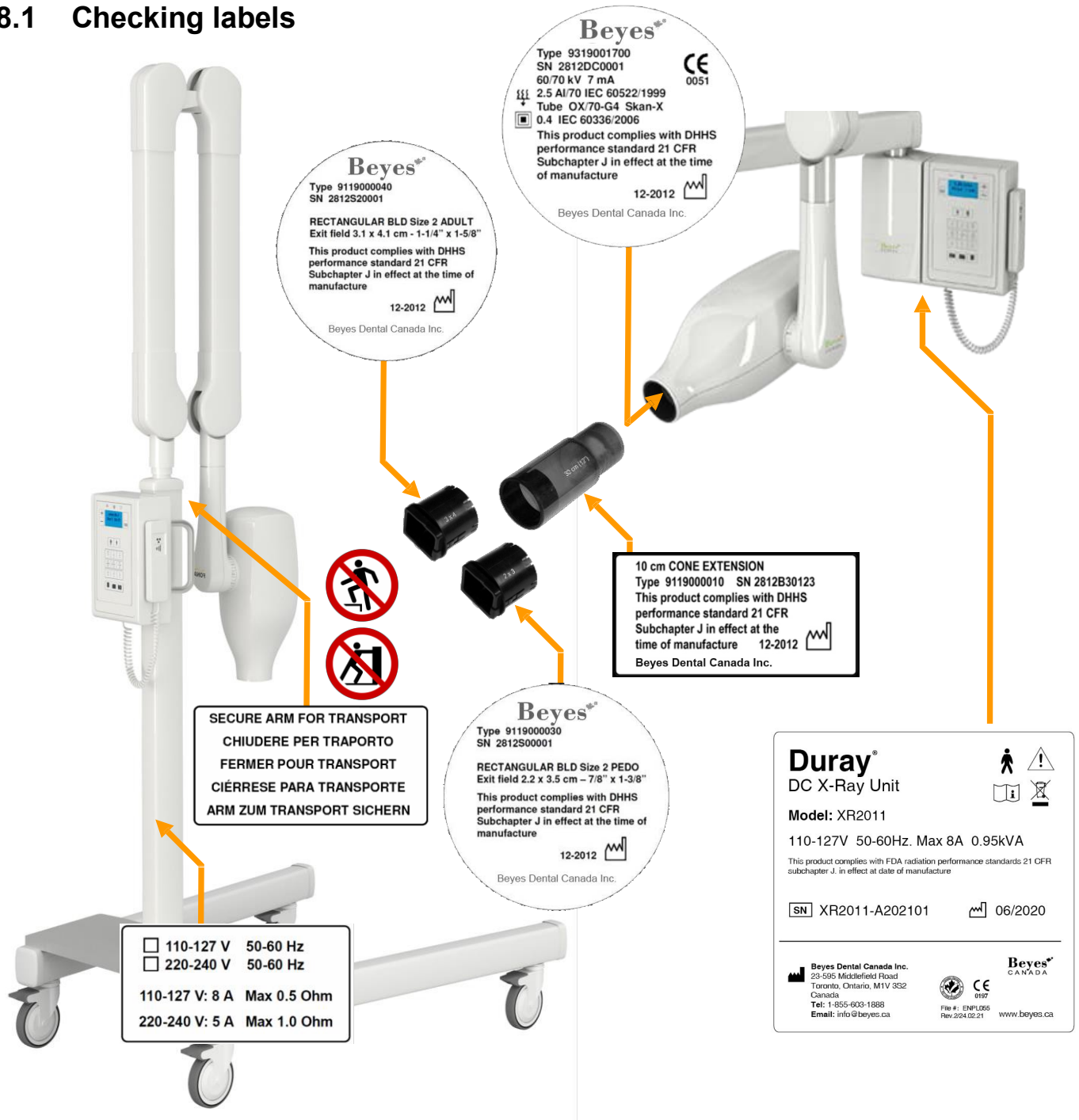

- Verify that all labels are in place and legible.
- Note. The warning label on the control panel is applicable for USA only.
- Defaced labels must be replaced. Order same from Beyes in writing stating:
 - Customer name and address.
 - Model and serial numbers still readable on the unit.

8.2 Maintenance of wall adaptor (WA)

Layout of conical spring washers on brake pin in WA. Size mm 12x6.2x0.6

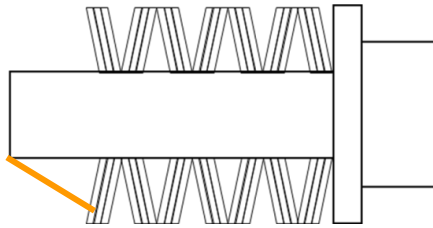

- A. The brake in the WA, which is acting laterally on the shaft of the SA, is made by a brass pin pushed by a screw through 21 conical spring washers assembled in 7 stacks facing in alternating direction (stacked in series), each stack being made of 3 conical spring washers facing the same direction (stacked in parallel).
- B. Remove the cover (screw under the unit) and verify that the mounting frame fully adheres to the wall and remains stable and firmly fixed during handling of the system.
- C. Verify tight connection of green-and-yellow earth conductors to the common bolt for earthing and bonding (PE point).
- D. Check the level of friction during movement of the SA and adjust it if needed.



WA brake tuning screw Allen 6 mm

8.3 Maintenance of support arm (SA)

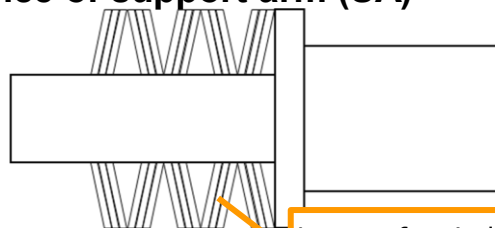

Layout of conical spring washers on brake pin in SA and in pole of mobile stand. Size mm 10x5.2x0.5

- A. The brake in the SA (same used in the pole of the mobile stand)), which is acting laterally on the shaft of the FA, is made by a brass pin pushed by a screw through 15 conical spring washers assembled in 5 stacks facing in alternating direction (stacked in series), each stack being made of 3 conical spring washers facing the same direction (stacked in parallel).
- B. Check the level of friction during movement of the FA and tune screw if needed.
- C. Verify tight connection of the green-and-yellow earth conductor to the arm.
- D. Verify 180° rotation of the SA into the WA, without exceeding the limit.



SA brake tuning screw Allen 6 mm

8.4 Maintenance of folding arm (FA)

- A. Inspect for wear of pins and levers:
 - a. Remove plastic covers.
 - b. Check for wearing out of pin and levers.
 - c. Make sure no part is loose.
 - d. Apply silicon spray lubricant if needed.
- B. Replace the worn-out parts or the arm itself if damaged. To replace defective pins or levers:
 - a. Have the THA disconnected and the arm fully open.
 - b. Loosen completely the two springs of the arm before extracting pins.
- C. Eventually mount back the THA and secure it with the retaining fork.
- D. Verify 330° rotation of the FA into the SA or 40° into the pole of the mobile

stand, without exceeding the limit.

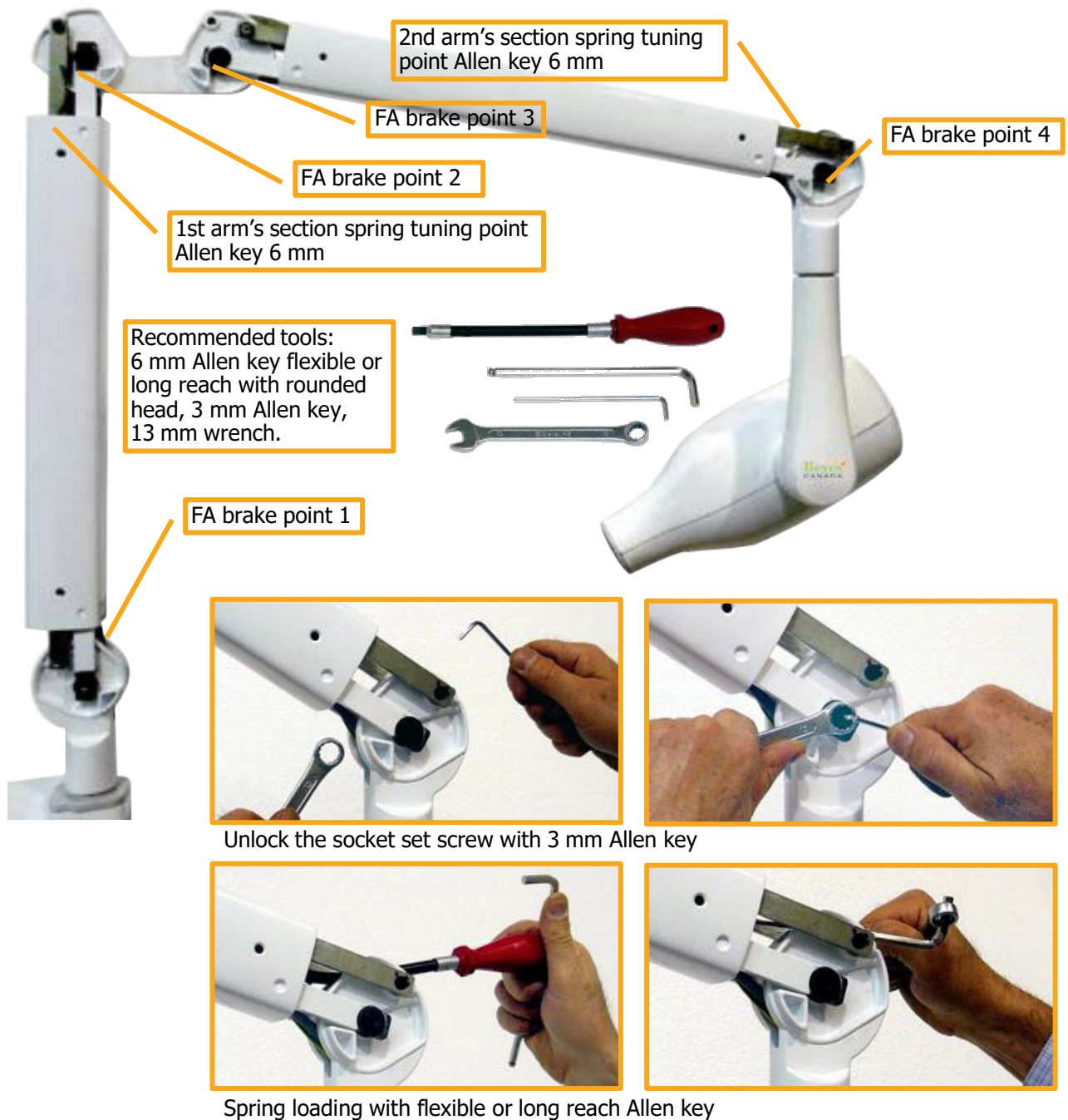

WARNING

Risk of breakage. Trying to loosen the brake pins without having loosened the socket set screw might lead to breaking the brake pins.

- E. If the FA is not supporting the load, do load the springs (2 sections) and tune the brakes (4 points) if needed, with the THA mounted.
To load the arm, for each arm's section:
 - a. Remove plastic covers at the joints.
 - b. Reduce the level of friction at the 2 relevant brake points by loosening the socket set screw (Allen 3 mm) into the female pin, then loosen both pins (13 mm wrenches).
 - c. Load the spring (using a 6 mm Allen key) for an even balancing of arm sections resting in an intermediate position.
 - d. Tighten the two brake pins introducing a little resistance to the movement, and eventually tighten the socket set screw to block the pins.
- F. Check for any damage or worn out conditions of the electrical cable in the arm.
- G. Make sure the protective earth wire is tightly connected to the arm.

8.5 Maintenance of THA

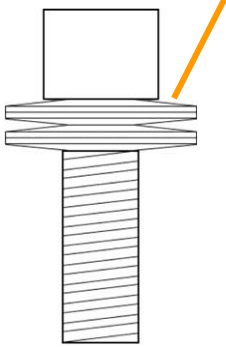

Layout of conical spring washers on the brake tuning screws in the THA. Size mm 10x3.2x0.5

- A. The brake in the joint of the THA, to control the stiffness of the rotation of the THA itself around the horizontal axis, is made by a circular nylon crown pressed by conical spring washers placed on 3 tuning screws all around. Each one of the 3 tuning screws is provided with 4 conical spring washers facing in alternating direction (stacked in series).
- B. Three other longer screws are placed all around alternating those to tune the brake, locked at the end of the stroke for safety reasons, so to prevent the circular nylon crown of the brake to detach in case the tuning screws become loose.
- C. Inspect for damages to the THA and its support system.
- D. Inspect the cone for possible damages and replace the THA in case.
- E. Inspect for any oil leakage and replace the THA in case.
- F. Check for smooth movement and position stability and tune brakes for desired friction, if necessary.
- G. Remove the plastic cover of the joint (Phillips screw at bottom) and:
 - a. Check the brass pin and the retaining clip and replace if damaged as well as worn down.
 - b. Verify 500° rotation of the THA around the vertical axis, without exceeding the limit.
 - c. Make sure the ground wires are tightly connected to the protective earth point.
 - d. Check that the electrical conductors are not damaged and fold well into the curl.
 - e. Make sure the screws for mechanical safety are properly tightened.
 - f. Verify that the three brake tuning screws (with conical spring washers) are tightened properly for a smooth rotation.
 - g. Verify 340° rotation of the THA around the horizontal axis, without exceeding the limit.
- H. Eventually put back the plastic cover of the joint.



8.6 Maintenance of the mobile stand

- A. Check that wheels and their brakes are working properly
- B. Make sure the protective earth (PE) conductor is tightly connected to the PE point on the mechanical frame.
- C. Tune the brake behind the SCU for desired friction when swinging the FA.
- D. Verify that the gland with spiral tail of the power supply cord is properly tightened and is not damaged
- E. Make sure the power supply cord and the plug are not damaged.

8.7 Maintenance of the system control unit (SCU)



- | | |
|---|---|
| Turning System ON | A. Turn the SCU ON with mains switch (A) and verify that the green light (B) indicating system ready turns ON at the end of the initialization procedure. |
| Test keys and lights | <p>B. Press all the kV key (G) and verify the change of kV level.</p> <p>C. Press plus key (E) and move to the maximum exposure value 3.2 s or 22.4 mAs.</p> <p>D. Press the minus key and go to the minimum exposure value 0.01 s or 0.07 mAs.</p> <p>E. Press each patient build key (H), change selection and verify green light.</p> <p>F. Press each anatomical region key (I, J, K), change selection and verify green light.</p> <p>G. Press each image receptor key (L), change selection and verify green light.</p> |
| Test Radiation Light and sound | <p>H. Using plus and minus keys set for an exposure of 1 s (7 mAs) or more.</p> <p>I. Direct the beam away making sure no one will be irradiated.</p> <p>J. Press the exposure button (N) and keep it pressed until the end of the exposure. Check for yellow light a (C and M) and for the sound of the buzzer during irradiation.</p> |
| Volunteer termination of irradiation (Dead Man functionality) | <p>K. Using plus and minus keys set for an exposure of 2.5 s. Direct the beam away making sure no one will be irradiated.</p> <p>L. Press the exposure button (N) and release it during the exposure. Verify that:</p> <ol style="list-style-type: none"> a. Irradiation is terminated immediately, signalled by the yellow light turned OFF and the buzzer sound terminated, b. The red alarm light (D) is turned ON and the error message E08 for premature termination appears on the display. |
| Turning System OFF | <p>M. Clear the error message and repeat the procedure in case.</p> <p>N. Turn the unit OFF with mains switch (A).</p> |
| Out of service | O. If the specified tests are not passed the unit cannot be used and has to be put out of service |

8.8 Mechanical checks

The examination to the mechanical parts of the system is divided in checks to be planned during the periodic inspection and activities to be carried out during preventive maintenance to be scheduled as recommended.

- Periodic inspection
- A. Mechanical status:
 - a. Check for overall mechanical integrity of components and of plastic covers and that no part is being attacked by corrosion.
 - b. Check for mechanical integrity of the BLD (collimator).
 - B. Make sure THA movements are performed within limits without exceeding:
 - a. 500° rotation of the THA around its vertical axis.
 - b. 340° rotation of the THA around its horizontal axis
- Call for technical service to fix any abnormality found.

- Maintenance activities
- A. Check and tuning of moving parts:
 - a. Check brake in WA. Tune in case.
 - b. Check brake in SA. Tune in case.
 - c. Inspect for wear of pins and levers of the FA. Lubricate in case. Note. Only minor wear is expected to occur in lifetime and without prejudice to the use.
 - d. Check springs and brakes in FA. Tune in case.
 - e. Check brakes in THA yoke. Tune in case.
 - f. Make sure the 3 safety screws in the brake of the THA yoke are fully engaged. Set properly in case.
 - g. Make sure the retaining fork holding the THA is working well. Correct in case.
- Call for technical service to fix any abnormality found.

8.9 Electrical Checks

The following checks are recommended during preventive maintenance:

- Cables and conductors
- A. Cabling integrity:
 - a. Make sure the supply cable into the side yoke of the THA is winding correctly during rotation. Set properly in case.
 - a. Check for integrity of supply cable and green-and-yellow conductor into the FA. Replace them in case of damages.
- Protective earth
- B. Check, and fix if necessary, for proper tightening of nuts and screws blocking the green-and-yellow conductors in PE points:
 - a. System control unit (SCU): PE points at bottom right and top right on the power driver board.
 - b. Wall adaptor (WA): PE point on the right side.
 - c. Support arm (SA): PE point behind the plastic cap at the mounting pin side.
 - d. Side joint of the THA: PE point at top centre.
 - e. Mobile stand (MS): PE point in the metal frame behind the SCU.
- Call for technical service to fix any abnormality found.

8.10 Anode current verification

WARNING



Risk wrong measurement



Measurements to be done by trained personnel only to avoid the risk of electrical shock or exposure to radiation.



The anode current is measured with a DC voltmeter set for 10 V DC, reading the voltage across the 1000 Ohm resistor in the anode circuit.

The voltage measured indicates the current flowing: 1 V is corresponding to 1 mA.

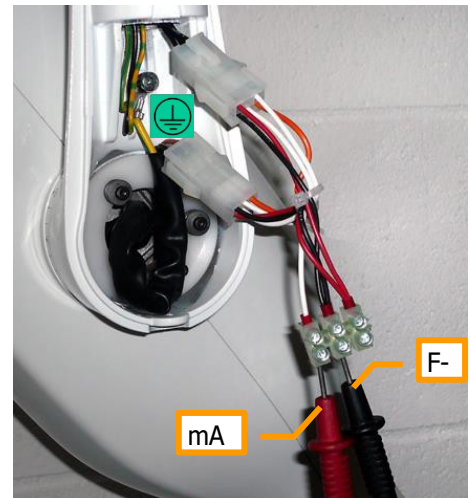

Turn System OFF

- A. Turn the unit OFF with mains switch below the SCU.
- B. Remove the plastic covers of the THA joint.
- C. Mount the THA test JIG for the measurement of anode current (and filament supply voltage in case) with a connection on the supply cable to the THA.
- D. Connect a multi-meter for DC voltage measurement, 10 V DC end of scale, between the connecting points of filament minus (GROUND) and mA.

Turn System ON

Set long exposure

- E. Turn the unit ON with mains switch below the SCU.
- F. Using plus and minus keys set for an exposure of 2 s (14 mAs) or more.
- G. Direct the beam away making sure no one will be irradiated.
- H. Press the exposure button (M) and keep it pressed until the end of the exposure reading the value indicated on the multi-meter;

during the exposure the value of 7 V \pm 10% is read (in the range from 6.3 to 7.7 V).

Record

- I. Record the readings

Turn System OFF





- J. Turn the SCU OFF with mains switch at bottom.
- K. Remove the measuring leads and put back the plastic cover.

Out of service

- L. If the specified values are not obtained the SCU cannot be used and has to be put out of service

8.11 Exposure Time and kV verification

WARNING

-  Risk wrong measurement
-  Measurements to be done by trained personnel only.
-  Place the radiation detector at about 50 cm (19 5/8") from the source (focal spot).
-  Set proper trigger level to measure the exposure time from the instant when the radiation dose rate for the first time reaches the 50% of the peak value and the instant when it finally drops below such value.



Non-invasive
kV and time meter

- A. In order to verify the exposure time and to measure the kV level a non invasive kV and time meter is used.

Turn System ON

- B. Turn the SCU ON with mains switch below the SCU.

60 kV, 2.80 mAs
s a 7 mA)

- C. Using plus and minus keys set for an exposure of 2.80 mAs (0.4 s at 7 mA) at 60 kV.
- a. Step back to a safe position
 - b. Expose and read the values of kV and time indicated by the meter:
 - c. Time to be $0.4 \text{ s} \pm 0.04$ (range 0.36 to 0.44 s).
 - d. kV value to be $60 \text{ kV} \pm 3 \text{ kV}$ (range 57 to 63 kV).
 - e. If the specified values are not obtained the SCU cannot be used and has to be put out of service.

70 kV, 3.5 mAs
s a 7 mA)

- D. Using plus and minus keys set for an exposure of 3.5 mAs (0.5 s at 7 mA) at 70 kV.
- a. Step back to a safe position
 - b. Press the exposure button (M) and keep it pressed until the end of the exposure reading the value indicated on the kV and time meter.
 - c. Time to be $0.5 \text{ s} \pm 0.05$ (range 0.45 to 0.55 s).
 - d. kV value to be $70 \text{ kV} \pm 3.5 \text{ kV}$ (range 66.5 to 73.5 kV).
 - e. If the specified values are not obtained the SCU cannot be used and has to be put out of service.

Record

- E. Record the readings.

Turn System OFF

- F. Turn the SCU OFF with mains switch at bottom.

8.12 Radiation dose assessment

WARNING



Risk wrong measurement



Measurements to be done by trained personnel only



It is recommended to place the radiation detector at 50 cm (19 5/8") from the radiation source (focal spot).



Dose meter

A. Use a radiation dose meter to verify the dose emitted.

Test object



In dental radiology a 6 mm Al filter (purity 99.9% or better) realizes a test object representative of an average patient. It can be placed in front of the output beam to evaluate the useful radiation level on the image receptor.

Turn System ON
60 kV, 7 mAs

- B. Turn the SCU ON with mains switch below the SCU.
C. Using plus and minus keys set for an exposure of 7 mAs (7 mA at 1.0 s) at 60 kV.
- Step back to a safe position.
 - Expose 3 times and take the average of the three measurements.
 - Acceptable values according to measurement distance in the table below.

Distance [cm]	Dose rate at 60 kV			
	20	50	70	100
Dose rate [μGy/s] ±20%	8400	1344	686	336
Dose rate with 6 mm Al filter [μGy/s] ±20%	1878	300	153	75

70 kV, 7 mAs

- D. Using plus and minus keys set for an exposure of 7 mAs (7 mA at 1.0 s) at 70 kV.
- Step back to a safe position.
 - Expose 3 times and take the average of the three measurements.
 - Acceptable values according to measurement distance in the table below.

Distance [cm]	Dose rate at 70 kV			
	20	50	70	100
Dose rate [μGy/s] ±20%	11200	1792	9145	448
Dose rate with 6 mm Al filter [μGy/s] ±20%	2851	456	233	114

Turn System OFF

- E. Record the readings.
F. Turn the SCU OFF with mains switch at bottom.

9. Reporting

The checklist forms for the servicing of the SCU are provided in the following:

- DURAY V2 Installation Report, to document proper assembly and installation.
- DURAY V2 C Checklist for Yearly Inspection, covering activities performed periodically every year.
- DURAY V2 Checklist for Preventive Maintenance, covering the maintenance activities, when applicable.

9.1 Installation report

The installation report contains the list of the checks to be performed at installation after assembly of the SCU which comes fully calibrated in manufacturing.

The form to be filled is structured as indicated.

Header	A. References <ul style="list-style-type: none">a. Customer name and addressb. Dealer name and addressc. Serial number of Tube Housing Assembly (THA)d. Serial number of System Control Unit (SCU)e. FDA form 2579 identification number (USA only)
Instrumentation	B. List of test instrumentation in use: <ul style="list-style-type: none">a. AC /DC Voltmeterb. kV and time meterc. X-ray radiation dose meter
Checks	C. List of checks to be performed as per manufacturer's indication: <ul style="list-style-type: none">a. Availability of manuals.b. Proper instrumentation in use.c. Mechanical status.d. System labels.e. Permanent installation (without the use of cord with plug).f. Second fuse enabled (two phases supply or cord connected with plug).g. Green-and-yellow conductors tightly secured in protective earth (PE) points.h. Functionality of keys on control panel.i. Functionality of lights on control panel.j. Functionality of irradiation indicators (yellow light and buzzer).k. Volunteer termination of irradiation (dead man functionality).
Compliance	D. Compliance statement upon positive conclusion of installation, or rejection.
Out of service	E. If the specified values are not obtained the SCU cannot be used and has to be put out of service.
Date and signature	F. The form is closed with: <ul style="list-style-type: none">a. Date and signature by customerb. Date and signature by technician

9.2 Report on periodic inspection and preventive maintenance

Schedule	<p>The DURAY V2 unit is a maintenance free equipment, requiring little or no maintenance, for which the following activities are recommended:</p> <ul style="list-style-type: none">• General inspections, by the operator, to be performed every year.• Preventive maintenance, by a skilled and trained technician, to be performed after 4, 7, 10 years from the date of installation and then every 2 years.
Header	<p>The report for inspection and maintenance contains both the general checks do be done periodically and the maintenance actions, when applicable.</p> <p>The form to be filled for the action items here listed is produced in the following.</p> <p>A. References</p> <ol style="list-style-type: none">a. Customer name and address.b. Dealer name and address.c. Serial number of Tube Housing Assembly (THA).d. Serial number of System Control Unit (SCU).e. FDA form 2579 identification number of the original form filled (USA only).
Instrumentation	<p>B. List of test instrumentation in use:</p> <ol style="list-style-type: none">a. AC /DC Voltmeterb. kV and time meterc. X-ray radiation dose meter
Checks for general inspection	<p>C. List of general checks to be performed yearly:</p> <ol style="list-style-type: none">a. Availability of manuals.b. Proper instrumentation.c. Mechanical status.d. System labels.e. Keys on control panel.f. Lights on control panel.g. Light and sound indicators upon irradiation.h. Activation and volunteer termination of irradiation.
Compliance upon inspection	<p>D. Compliance statement upon positive conclusion of general inspection, or rejection.</p>
Preventive maintenance schedule Checks for preventive maintenance	<p>E. When carried out, check the applicable time period for preventive maintenance: 4, 7, 10, 12, 14, 16, 18, or 20 years from the date of installation.</p> <p>F. List of preventive maintenance activities to be performed as per schedule:</p> <ol style="list-style-type: none">a. Mechanical checks (arm balance, friction of brakes, wear).b. Verification of tight connection of green-and-yellow wires at protective earth (PE) points.c. Accuracy of anode voltage.d. Accuracy of anode current.e. Accuracy of exposure time.f. Adequacy of irradiation level
Compliance upon maintenance	<p>G. Compliance statement upon positive conclusion of periodic maintenance or rejection.</p>
Out of service	<p>H. If the specified values are not obtained the unit cannot be used and has to be put out of service</p>
Date and signature	<p>I. The form is closed with:</p> <ol style="list-style-type: none">a. Date and signature by customerb. Date and signature by technician

DURAY V2 INSTALLATION REPORT

Customer:		Dealer:	
	Serial number	Date of installation:	
Tube housing assembly (THA)		Report of assembly FDA 2579 #	
System Control Unit (SCU)			

TEST INSTRUMENTATION

	Manufacturer	Model	Accuracy	Last calibrated
AC /DC Voltmeter				
kV and time meter				
X-ray dose meter				

SCHEDULE

	Yes	No	REMARKS
All manuals are present	<input type="checkbox"/>	<input type="checkbox"/>	
Test instruments are as required	<input type="checkbox"/>	<input type="checkbox"/>	
No mechanical damage noticed	<input type="checkbox"/>	<input type="checkbox"/>	
All labels are present and legible	<input type="checkbox"/>	<input type="checkbox"/>	
The unit is permanently installed (without the use of plug)	<input type="checkbox"/>	<input type="checkbox"/>	
Second mains fuse enabled (on mobile due to use of plug)	<input type="checkbox"/>	<input type="checkbox"/>	
Green-and-yellow wires at PE points are tightly secured	<input type="checkbox"/>	<input type="checkbox"/>	
Keys on control panel are working properly	<input type="checkbox"/>	<input type="checkbox"/>	
Lights on control panel are working properly	<input type="checkbox"/>	<input type="checkbox"/>	
The light and sound indicators upon irradiation work	<input type="checkbox"/>	<input type="checkbox"/>	
The activation and volunteer termination of irradiation work	<input type="checkbox"/>	<input type="checkbox"/>	
Compliance to above listed performance and safety tests	<input type="checkbox"/>	<input type="checkbox"/>	

Notes:

Technician	Customer
Date: _____	Date: _____
Signature: _____	Signature: _____

DURAY V2 CHECKLIST for YEARLY INSPECTION

Customer:	Dealer:	
	Serial number	Date of installation:
Tube housing assembly (THA)		Report of assembly FDA 2579 #
System Control Unit (SCU)		

TEST INSTRUMENTATION

	Manufacturer	Model	Accuracy	Last calibrated
AC /DC Voltmeter				
kV and time meter				
X-ray dose meter				

SCHEDULE	yes	no	REMARKS
All manuals are present	<input type="checkbox"/>	<input type="checkbox"/>	
No mechanical damage noticed	<input type="checkbox"/>	<input type="checkbox"/>	
All labels are present and legible	<input type="checkbox"/>	<input type="checkbox"/>	
All pushbuttons on control panel are working properly	<input type="checkbox"/>	<input type="checkbox"/>	
All indicator lights on control panel are working properly	<input type="checkbox"/>	<input type="checkbox"/>	
X-ray radiation indicator lights up, the buzzer is audible	<input type="checkbox"/>	<input type="checkbox"/>	
X-ray hand-switch and dead-man functionality are working	<input type="checkbox"/>	<input type="checkbox"/>	
The unit complies with the above indicated tests	<input type="checkbox"/>	<input type="checkbox"/>	

DURAY V2 CHECKLIST for PREVENTIVE MAINTENANCE

4 year
 7 year
 10 year
 12 year
 14 year
 16 year
 18 year
 20 year

SCHEDULE	yes	no	REMARKS
Test instruments as required	<input type="checkbox"/>	<input type="checkbox"/>	
Mechanical checks (arm balance, friction of brakes, wear).	<input type="checkbox"/>	<input type="checkbox"/>	
Green yellow wires at PE points are tightly secured	<input type="checkbox"/>	<input type="checkbox"/>	
Anode Voltage at 60 kV is within specified limits	<input type="checkbox"/>	<input type="checkbox"/>	kV
Tube current at 60 kV is within specified limits	<input type="checkbox"/>	<input type="checkbox"/>	mA
Anode Voltage at 70 kV is within specified limits	<input type="checkbox"/>	<input type="checkbox"/>	kV
Tube current at 70 kV is within specified limits	<input type="checkbox"/>	<input type="checkbox"/>	mA
Exposure time at 0.5 s is within limits	<input type="checkbox"/>	<input type="checkbox"/>	s
Radiation dose rate at 70 kV at 50 cm /19 5/8" distance	<input type="checkbox"/>	<input type="checkbox"/>	µGy/s
The unit complies with the above indicated tests	<input type="checkbox"/>	<input type="checkbox"/>	

Technician	Customer
Date: _____ Signature: _____	Date: _____ Signature: _____



Federal law restricts this device to sale by or on the order of a dentist, physician, or any other practitioner licensed by the law of the states in which he or she practices to use or order the use of this device.

Beyes Dental Canada Inc.
23-595 Middlefield Road
Scarborough, Ontario,
M1V 3S2 Canada
Tel: 1-855-603-1888
Fax: 1-855-720-1228
Email: info@beyes.ca
Website: www.beyes.ca



Lotus NL B.V.
Koningin Julianaplein 10, le Verd,
2595AA, The Hague,
Netherlands



Printed in Canada
ENI040
Rev.2/09.26.24